

Mayor
CERÁMICA ■■■■

2023

Mayor
CERÁMICA ■■■■

Index

Índice

4	About us <i>Quiénes somos</i>	158	Mikonos
11	What do we do <i>Qué hacemos</i>	162	Bora
12	Symbology <i>Simbología</i>	166	Canarias
13	Reading the catalogue <i>Lectura del catálogo</i>	170	Aruba
15	Collections <i>Colecciones</i>	174	Drain grates <i>Rejillas de drenaje</i>
17	Crosscut	178	Trim <i>Media caña</i>
27	Lao	180	Cooping solutions for swimming pools <i>Soluciones de coronación de piscinas</i>
37	Cupira	182	Placement recommendations <i>Recomendaciones de montaje</i>
47	Salem	183	Procedure for ceramic pieces placement in pools <i>Manual de colocación de piezas cerámicas en piscinas</i>
59	Calacatta	184	Procedure for placement and maintenance <i>Procedimiento para la colocación y mantenimiento</i>
69	Eterna	188	Pieces dimensions <i>Dimensiones de las piezas</i>
79	Stromboli	189	Technical information <i>Información técnica</i>
93	Cements	190	Packing list
103	Amazonia	194	Collections overview <i>Resumen colecciones</i>
113	Woods		
123	Sea Rock		
129	Tropic		
139	Bali		
145	Pool solutions <i>Soluciones de piscina</i>		
146	Creta		
150	Samoa		
154	Maui		



About us

Quiénes somos

Tradition

Tradicón

Cerámica Mayor S.A. is a leading company in the manufacture of extruded material with a long tradition in the production of pavements and special pieces, both in natural and glazed finish. The company was founded in the last century by D. Fernando Mayor Boluda and today it is directed by the Mayor brothers. Since its inception, it has kept its values, beliefs and customs intact, transmitting them from generation to generation and applying them to each and every form of expression.

Cerámica Mayor S.A. es una empresa líder en la fabricación de material extrusionado con una larga tradición en la producción de pavimentos y piezas especiales, tanto en acabado natural como esmaltado. La empresa fue fundada en el siglo pasado por D. Fernando Mayor Boluda y hoy en día es dirigida por los hermanos Mayor. Desde sus inicios ha mantenido intactos sus valores, creencias y costumbres, transmitiéndolas de generación en generación y aplicándolas a todas y cada una de sus formas de expresión.

Experience

Experiencia

We are a family business that has the know-how of three generations. From the first, from which we inherited the knowledge of clay and fire, through the entrepreneurial generation that changed the concept of manual enterprise to a factory with state-of-the-art technology and machinery, to the latest and newest generation, which seeks to make use of new technologies to enhance our product.

Somos una empresa familiar que cuenta con el saber hacer de tres generaciones. Desde la primera, de la cual heredamos el conocimiento de las arcillas y el fuego, pasando por la generación emprendedora que cambió el concepto de empresa manual a una fábrica con tecnología y maquinaria puntera, a la última y más reciente generación, que intenta hacer uso de las nuevas tecnologías para potenciar nuestro producto.





Team *Equipo*

Currently we are a team of 100 people working with professionalism and perseverance to achieve a common objective: the excellence of our products. Our technical department, specialized in architecture, engineering, construction and design, is involved in each project, from the approach until its completion, creating synergies with each customer throughout the whole process with the aim of achieving product excellence.

Actualmente somos un equipo de 100 personas que trabajamos con profesionalidad y perseverancia para lograr un objetivo común: la excelencia en nuestros productos. Nuestro departamento técnico, experto en arquitectura, ingeniería, construcción y diseño, se involucra en cada proyecto, desde el planteamiento hasta su finalización, creando sinergias con cada cliente a lo largo de todo el proceso con el objetivo de lograr la excelencia en el producto.

Quality *Calidad*

All our pieces are subjected to rigorous controls of quality throughout the production process. They are tested, among other things, mechanical and thermal shock resistance, the chemical resistance of the glazing, the purity of its components and the stability of its forms. In short, an integral quality control, from the selection of clays to the final packaging to ensure that the product is in perfect condition.

Todas nuestras piezas se someten a rigurosos controles de calidad en todo el proceso de producción. Se prueban entre otras cosas la resistencia mecánica y a choques térmicos, la resistencia química del esmalte, la pureza de sus componentes y la estabilidad de sus formas. En definitiva, un control de calidad integral, desde la selección de arcillas hasta el embalaje final para asegurar que el producto está en perfecto estado.

Innovation

Innovación

Since the beginning we have been committed to innovation in production processes without losing our traditional character. Cerámica Mayor has facilities adapted to meet the needs of an increasingly professional and demanding market. Our R+D team is constantly researching to generate products that offer high-end technical and aesthetic features.

Desde los inicios hemos apostado por la innovación en los procesos productivos sin perder nuestro carácter tradicional. Cerámica Mayor cuenta con instalaciones adaptadas para cumplir con las necesidades de un mercado cada vez más profesional y exigente. Nuestro equipo de I+D investiga constantemente para generar productos que ofrezcan prestaciones técnicas y estéticas de alta gama.

Eco-friendly

Ecológicos

The conservation and respect of the natural and environmental surroundings is part of the conditioning factors of our industrial process. Our pavement is made up of 50% recycled material. We recover 100% of the waste generated and reincorporate 100% of the water used in the process ensuring zero waste. All the links in the production chain are designed to facilitate the recycling of materials.

La conservación y el respeto del entorno natural y medioambiental forma parte de los condicionantes de nuestro proceso industrial. Nuestro pavimento se compone de un 50% de material reciclado. Recuperamos el 100% de los residuos generados y reincorporamos el 100% del agua utilizada en el proceso asegurando un vertido cero. Todos los eslabones de la cadena productiva están pensados para facilitar el reciclado de los materiales.





What we do

Qué hacemos

Cerámica Mayor

Cerámica Mayor is a leading company in the manufacture of extruded material. Founded in the last century, it has been adapting and modernizing to be at the forefront of the ceramic sector.

We are specialised in the creation of special pieces to solve the constructive problems that we find in our ongoing and future projects.

Cerámica Mayor es una empresa líder en la fabricación de material extrusionado. Fundada en el siglo pasado, se ha ido adaptando y modernizando para estar a la vanguardia del sector cerámico.

Estamos especializados en la creación de piezas especiales para solucionar los problemas constructivos que nos encontramos en cada uno de nuestros proyectos.





















Future *Futuro*

Our project for the future is a clear commitment to face the new challenges that the market demands in terms of sustainable architecture. The new way of designing and constructing buildings is, to achieve a building that respects the natural environment and improves the quality of life. Our untiring search for new applications and the study of materials, together with the spirit of our team, make us a highly qualified company to respond to needs of future bioclimatic architecture.

Nuestro proyecto de futuro es una rotunda apuesta para afrontar los nuevos retos que demanda el mercado en cuanto a arquitectura sostenible. La nueva forma de proyectar y construir edificios pasa, sin lugar a dudas, por lograr una edificación que respete el entorno natural y mejore la calidad de vida. Nuestra incansable búsqueda de nuevas aplicaciones y el estudio de los materiales, junto con el espíritu de nuestro equipo, hacen de nosotros una empresa altamente cualificada para dar respuesta a las necesidades de la arquitectura bioclimática del futuro.

Symbology

Simbología

	Outdoor pieces and tiles class 3 <i>Piezas y bases de exterior clase 3</i>		Tile of Spain vinculated enterprise <i>Empresa vinculada a Tile of Spain</i>
	Indoor pieces and tiles class 1 <i>Piezas y bases de interior class 1</i>		ISO 9001 certificated by AENOR <i>Certificado ISO 9001 por AENOR</i>
60x120 ^R	Size in centimetres <i>Tamaño en centímetros</i>		Sustainable tiles certificated <i>Certificado de baldosas sostenibles</i>
90x90 ^R	Rectified tiles <i>Bases rectificadas</i>		Management system certificated by IQNET <i>Certificado de gestión de sistema por IQNET</i>
31x83 [*]	Not rectified tiles <i>Bases sin rectificar</i>		ASCER vinculated enterprise <i>Empresa vinculada a ASCER</i>
	Real shape of the piece <i>Tamaño real de la pieza</i>		Environmental Product Declaration <i>Declaración Ambiental de Producto</i>
	Non-slip Class 3 <i>Antideslizante Clase 3</i>		
	Non-slip Class 1 <i>Antideslizante Clase 1</i>		
MONOBLOCK	Made in one piece, not glued <i>Fabricado de una pieza, sin pegado</i>		
	Rubber cushioning system <i>Sistema con goma de amortiguación</i>		
 Worldwide Patent Patente Mundial	Worldwide patent of the piece <i>Patente mundial de la pieza</i>		
Art. 9710	Article number <i>Número del artículo</i>		
	UNE 41901		
	EN ISO 10545-12		
	DIN 51130		
	DIN 51097		
	EN ISO 10545-13		
	Long life product <i>Producto de larga vida</i>		
	Easy to clean product <i>Producto de fácil limpieza</i>		

Reading the catalogue

Lectura del catálogo

- 01 Collection name
Nombre de la colección
- 02 Colores disponibles
Available colours
- 03 Formatos disponibles
Available formats
- 04 Other available finishes
Otros acabados disponibles
- 05 Packing data
Datos de cantidades y embalaje
- 06 Special pieces
Piezas especiales
- 07 Sistema de piscina
Pool system
- 08 Edge available colours
Colores disponibles del borde
- 09 Placement possibilities
Posibilidades de colocación
- 10 Technical information
Características técnicas

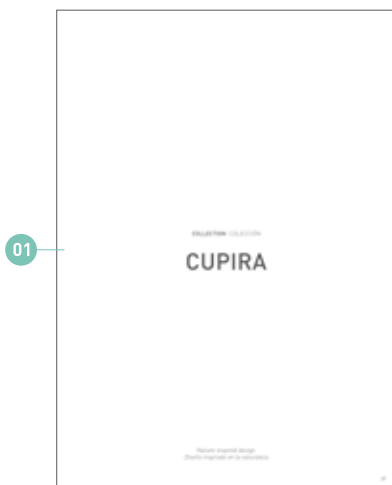





Collections
Colecciones



COLLECTION *COLECCIÓN*

CROSSCUT

Innovation in the art of stone tiles
Innovación en el arte de las piedras cerámicas

COLOURS
COLORES

PETRA



CLOUD



FORMATS
FORMATOS

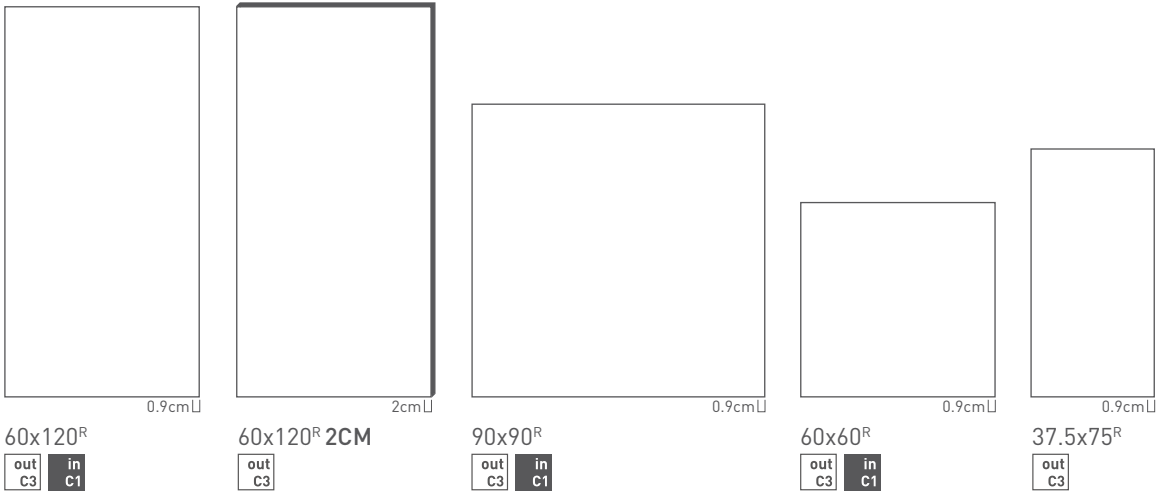

[^R] Rectified tiles - Bases rectificadas

OTHER FINISHES
OTROS ACABADOS



9x60
Skirting board
Rodapié



14.5x120
Riser
Tabica

PACKING
EMBALAJE

formats formatos	pieces / box piezas / caja	sqm / box m ² / caja	kg / box kg / caja	pieces / pallet piezas / palet	pallet sizes medidas palet
60x120 ^R	2	1,4400	30,00	72	120x84x74
60x120 ^R 2CM	1	0,7200	34,37	27	120x84x74
90x90 ^R	2	1,6200	42,25	54	106x95x74
60x60 ^R	4	1,4400	27,00	128	120x80x74
37.5x75 ^R	4	1,1250	23,50	220	120x80x89
9x60 Skirting board/ <i>Rodapié</i>	10	-	17,73	1440	110x95x110
14.5x120 Riser/ <i>Tabica</i>	6	-	22,20	450	125x110x90

STEP
PELDAÑO



RECTO STEP
PELDAÑO RECTO
33x120



RECTO STEP CORNER
PELDAÑO RECTO TAPA
33x120



FULL STEP
PELDAÑO COMPLETO
33x120



POOL EDGES
BORDES DE PISCINA



CRETA EDGE
BORDE CRETA
33x50x2.5



SAMOA EDGE
BORDE SAMOA
50x120x2.5



MAUI EDGE
BORDE MAUI
33x50x2.5



BORA EDGE
BORDE BORA
20x50x3.4



CANARIAS SUPPORT EDGE
BORDE SOPORTE CANARIAS
18x50x3.4



ARUBA EDGE
BORDE ARUBA
25x50x3.4



DRAIN GRATES
REJILLAS DE DRENAJE



CERAMIC DRAIN GRATE
REJILLA DE DRENAJE CERÁMICA
RJ20 0000 20x50x2.2



Drain - Desagüe: >11m³/hora
Grate rubber 9710 included
Goma p/rejilla 9710 incluida



CERAMIC FLEX DRAIN GRATE
REJILLA DE DRENAJE CERÁMICA FLEX
RJ20 FLEX 20x50x2.2



Drain - Desagüe: >30m³/hora
Grate rubber 9710 included
Goma p/rejilla 9710 incluida



CERAMIC DRAIN GRATE
REJILLA DE DRENAJE CERÁMICA
RJ25 0000 25x50x2.2



Drain - Desagüe: >13m³/hora
Grate rubber 9710 included
Goma p/rejilla 9710 incluida



CERAMIC DRAIN GRATE
REJILLA DE DRENAJE CERÁMICA
RJ25 FLEX 25x50x2.2



Drain - Desagüe: >30m³/hora
Grate rubber 9710 included
Goma p/rejilla 9710 incluida



Component: Grate rubber
Componente: Goma p/Rejilla
Art. 9710

TRIM
PIEZAS TERMINACIÓN



Outer trim
Media caña exterior
MDCA E000 4.5x50



Scotch outer corner
Escocia cantonera exterior
MDCA EE00 4.5x4.5



Outer angle corner
Esquina cantonera exterior
MDCA AE00 6.5x6.5



External transition corner
Cantonera transición exterior
MDCA CE00 4.5x16



Inner trim
Media caña interior
MDCA I000 5.5x50



Scotch inner corner
Escocia cantonera interior
MDCA EI00 5.5x5.5



Inner angle corner
Esquina cantonera interior
MDCA AI00 6.5x6.5



Inner transition corner
Cantonera transición interior
MDCA CI00 5.5x16

*Detailed information about trim in pages 178 and 179
*Información detallada sobre las piezas de terminación en las páginas 178 y 179









CROSCUT CLOUD



COLLECTION *COLECCIÓN*

LAO

The natural elegance
La elegancia natural

COLOURS
COLORES

BONE



SAND



ASH



FORMATS
FORMATOS

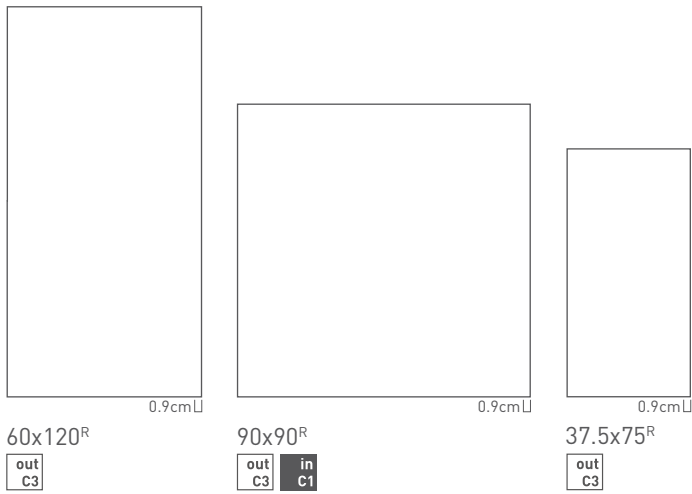

[^R] Rectified tiles - Bases rectificadas

OTHER FINISHES
OTROS ACABADOS



9x60
Skirting board
Rodapié



14.5x120
Riser
Tabica

PACKING
EMBALAJE

formats formatos	pieces / box piezas / caja	sqm / box m ² / caja	kg / box kg / caja	pieces / pallet piezas / palet	pallet sizes medidas palet
60x120 ^R	2	1,4400	30,00	72	120x84x74
90x90 ^R	2	1,6200	42,25	54	106x95x74
37.5x75 ^R	4	1,1250	23,50	220	120x80x89
9x60 Skirting board/ <i>Rodapié</i>	10	-	17,73	1440	110x95x110
14.5x120 Riser/ <i>Tabica</i>	6	-	22,20	450	125x110x90

STEP
PELDAÑO



RECTO STEP
PELDAÑO RECTO
33x120



RECTO STEP CORNER
PELDAÑO RECTO TAPA
33x120



POOL EDGES
BORDES DE PISCINA



CRETA EDGE
BORDE CRETA
33x50x2.5



SAMOA EDGE
BORDE SAMOA
50x120x2.5



MAUI EDGE
BORDE MAUI
33x50x2.5



DRAIN GRATES
REJILLAS DE DRENAJE



CERAMIC DRAIN GRATE
REJILLA DE DRENAJE CERÁMICA
RJ25 0000 25x50x2.2



Drain - Desagüe: >13m³/hora
Grate rubber 9710 included
Goma p/rejilla 9710 incluida



CERAMIC FLEX DRAIN GRATE
REJILLA DE DRENAJE CERÁMICA FLEX
RJ25 FLEX 25x50x2.2



Drain - Desagüe: >30m³/hora
Grate rubber 9710 included
Goma p/rejilla 9710 incluida



Component: Grate rubber
Componente: Goma p/Rejilla
Art. 9710

TRIM
PIEZAS TERMINACIÓN



Outer trim
Media caña exterior
MDCA E000 4.5x50



Scotch outer corner
Escocia cantonera exterior
MDCA EE000 4.5x4.5



Outer angle corner
Esquina cantonera exterior
MDCA AE000 6.5x6.5



External transition corner
Cantonera transición exterior
MDCA CE000 4.5x16



Inner trim
Media caña interior
MDCA I000 5.5x50



Scotch inner corner
Escocia cantonera interior
MDCA EI000 5.5x5.5



Inner angle corner
Esquina cantonera interior
MDCA AI000 6.5x6.5



Inner transition corner
Cantonera transición interior
MDCA CI000 5.5x16

*Detailed information about trim in pages 178 and 179
*Información detallada sobre las piezas de terminación en las páginas 178 y 179

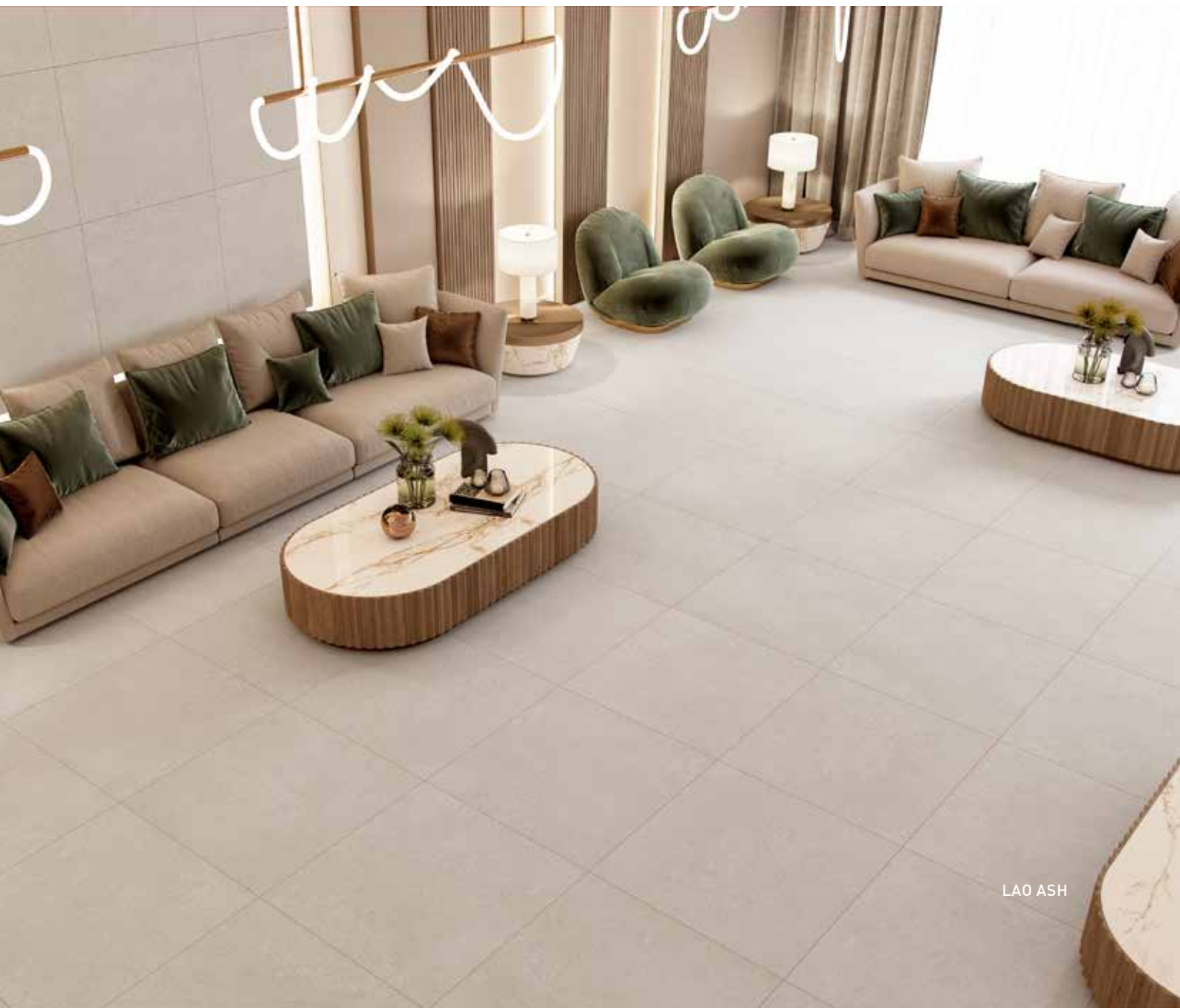











COLLECTION *COLECCIÓN*

CUPIRA

Nature-inspired design
Diseño inspirado en la naturaleza

COLOURS
COLORES

MULTI



MARENGO



HUESO



FORMATS
FORMATOS

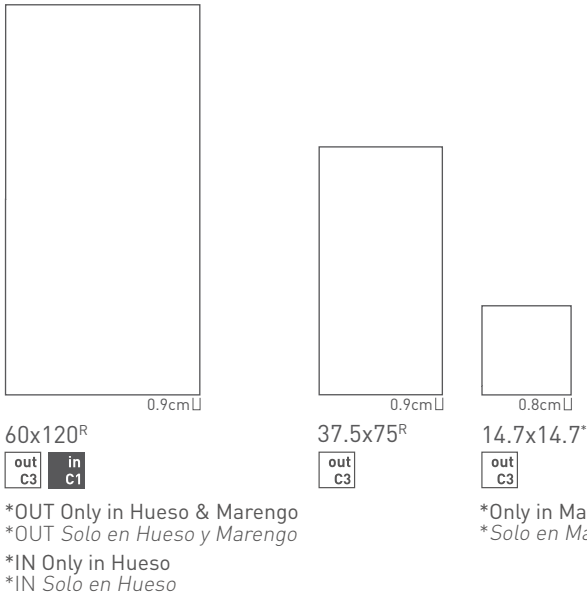

[^R] Rectified tiles - Bases rectificadas | [^{*}] Not rectified tiles - Bases sin rectificar

OTHER FINISHES
OTROS ACABADOS

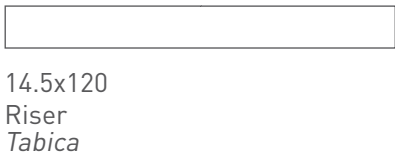
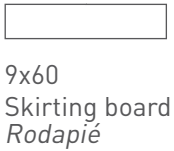

PACKING
EMBALAJE

formats formatos	pieces / box piezas / caja	sqm / box m ² / caja	kg / box kg / caja	pieces / pallet piezas / palet	pallet sizes medidas palet
60x120 ^R	2	1,4400	30,00	72	120x84x74
37.5x75 ^R	4	1,1250	23,50	220	120x80x89
14.7x14.7 [*]	44	0,9508	16,97	3520	120x80x89
9x60 Skirting board/ <i>Rodapié</i>	10	-	17,73	1440	110x95x110
14.5x120 Riser/ <i>Tabica</i>	6	-	22,20	450	125x110x90

STEP
PELDAÑO



RECTO STEP
PELDAÑO RECTO
33x120



*IN only in Hueso
*IN solo en Hueso



RECTO STEP CORNER
PELDAÑO RECTO TAPA
33x120



*IN only in Hueso
*IN solo en Hueso

POOL EDGES
BORDES DE PISCINA



CRETA EDGE
BORDE CRETA
33x50x2.5



DRAIN GRATES
REJILLAS DE DRENAJE



CERAMIC DRAIN GRATE
REJILLA DE DRENAJE CERÁMICA
RJ25 0000 25x50x2.2



Drain - Desagüe: >13m³/hora
Grate rubber 9710 included
Goma p/rejilla 9710 incluida



CERAMIC FLEX DRAIN GRATE
REJILLA DE DRENAJE CERÁMICA FLEX
RJ25 FLEX 25x50x2.2



Drain - Desagüe: >30m³/hora
Grate rubber 9710 included
Goma p/rejilla 9710 incluida



Component: Grate rubber
Componete: Goma p/Rejilla
Art. 9710

TRIM
PIEZAS TERMINACIÓN



Outer trim
Media caña exterior
MDCA E000 4.5x50



Scoth outer corner
Escocia cantonera exterior
MDCA EE000 4.5x4.5



Outer angle corner
Esquina cantonera exterior
MDCA AE000 6.5x6.5



External transition corner
Cantonera transición exterior
MDCA CE000 4.5x16



Inner trim
Media caña interior
MDCA I000 5.5x50



Scoth inner corner
Escocia cantonera interior
MDCA EI000 5.5x5.5



Inner angle corner
Esquina cantonera interior
MDCA AI000 6.5x6.5



Inner transition corner
Cantonera transición interior
MDCA CI000 5.5x16

*Detailed information about trim in pages 178 and 179
*Información detallada sobre las piezas de terminación en las páginas 178 y 179



CUPIRA MARENGO





CÚPIRA MULTI





CUPIRA HUESO & CUPIRA MULTI



COLLECTION *COLECCIÓN*

SALEM

The natural stone design
El diseño de la piedra natural

COLOURS
COLORES

CLAR



DUNE



FORMATS

FORMATOS

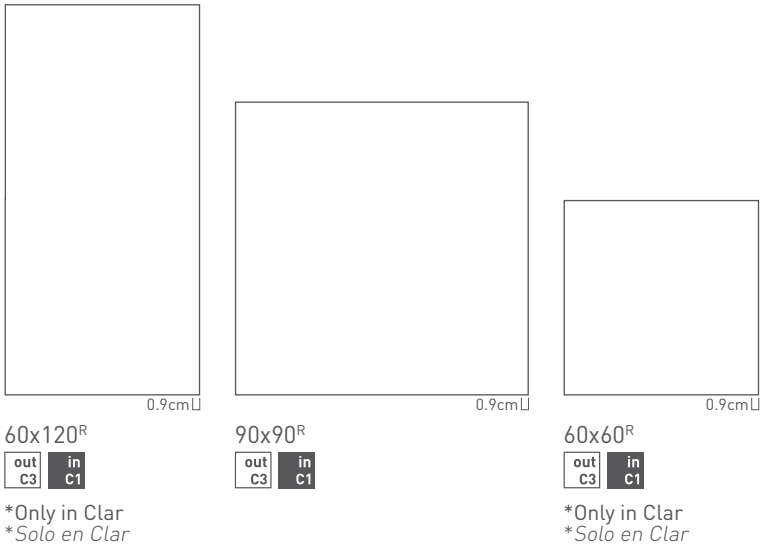

(^R) Rectified tiles - Bases rectificadas

OTHER FINISHES

OTROS ACABADOS



9x60
 Skirting board
 Rodapié



14.5x120
 Riser
 Tabica

PACKING

EMBALAJE

formats formatos	pieces / box piezas / caja	sqm / box m ² / caja	kg / box kg / caja	pieces / pallet piezas / palet	pallet sizes medidas palet
60x120 ^R	2	1,4400	30,00	72	120x84x74
90x90 ^R	2	1,6200	42,25	54	106x95x74
60x60 ^R	4	1,4400	27,00	128	120x80x74
9x60 Skirting board/Rodapié	10	-	17,73	1440	110x95x110
14.5x120 Riser/Tabica	6	-	22,20	450	125x110x90

STEP PELDAÑO



RECTO STEP
PELDAÑO RECTO
33x120

out	in
c3	c1



RECTO STEP CORNER
PELDAÑO RECTO TAPA
33x120

out	in
c3	c1

POOL EDGES BORDES DE PISCINA



CRETA EDGE
BORDE CRETA
33x50x2.5

out
c3

*Only in Clar
*Solo en Clar



SAMOA EDGE
BORDE SAMOA
50x120x2.5

out
c3

*Only in Clar
*Solo en Clar



MAUI EDGE
BORDE MAUI
33x50x2.5

out
c3

*Only in Clar
*Solo en Clar

DRAIN GRATES REJILLAS DE DRENAJE



CERAMIC DRAIN GRATE
REJILLA DE DRENAJE CERÁMICA
RJ20 0000 20x50x2.2



*Only in Clar
*Solo en Clar

Drain - Desagüe: >11m³/hora
Grate rubber 9710 included
Goma p/rejilla 9710 incluida

ANTISHOCK Worldwide Patent
Patente Mundial



CERAMIC FLEX DRAIN GRATE
REJILLA DE DRENAJE CERÁMICA FLEX
RJ20 FLEX 20x50x2.2



*Only in Clar
*Solo en Clar

Drain - Desagüe: >30m³/hora
Grate rubber 9710 included
Goma p/rejilla 9710 incluida

ANTISHOCK Worldwide Patent
Patente Mundial

DRAIN GRATES

REJILLAS DE DRENAJE



CERAMIC DRAIN GRATE
REJILLA DE DRENAJE CERÁMICA
RJ25 0000 25x50x2.2



*Only in Clar
 *Solo en Clar

Drain - Desagüe: >13m³/hora
Grate rubber 9710 included
Goma p/rejilla 9710 incluida



CERAMIC FLEX DRAIN GRATE
REJILLA DE DRENAJE CERÁMICA FLEX
RJ25 FLEX 25x50x2.2



*Only in Clar
 *Solo en Clar

Drain - Desagüe: >30m³/hora
Grate rubber 9710 included
Goma p/rejilla 9710 incluida



Component: Grate rubber
Componente: Goma p/Rejilla
Art. 9710

TRIM

PIEZAS TERMINACIÓN



Outer trim
Media caña exterior
MDCA E000 4.5x50



Scotch outer corner
Escocia cantonera exterior
MDCA EE000 4.5x4.5



Outer angle corner
Esquina cantonera exterior
MDCA AE000 6.5x6.5



External transition corner
Cantonera transición exterior
MDCA CE000 4.5x16



Inner trim
Media caña interior
MDCA I000 5.5x50



Scotch inner corner
Escocia cantonera interior
MDCA EI000 5.5x5.5



Inner angle corner
Esquina cantonera interior
MDCA AI000 6.5x6.5



Inner transition corner
Cantonera transición interior
MDCA CI000 5.5x16

*Detailed information about trim in pages 178 and 179
 *Información detallada sobre las piezas de terminación en las páginas 178 y 179

*Trim: Only in Clar
 *Piezas de terminación: Solo en Clar



coffee shop
— fresh water —



coffee shop
fresh roasted







SALEM CLAR





SALEM CLAR



COLLECTION *COLECCIÓN*

CALACATTA

Infinite spaces full of purity and elegance
Espacios infinitos llenos de pureza y elegancia

COLOURS
COLORES

FRESH



FORMATS
FORMATOS

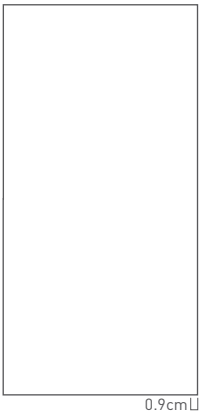

60x120^R



[^R] Rectified tiles - Bases rectificadas

OTHER FINISHES
OTROS ACABADOS



9x60
Skirting board
Rodapié



14.5x120
Riser
Tabica

PACKING
EMBALAJE

formats formatos	pieces / box piezas / caja	sqm / box m ² / caja	kg / box kg / caja	pieces / pallet piezas / palet	pallet sizes medidas palet
60x120 ^R	2	1,4400	30,00	72	120x84x74
9x60 Skirting board/ <i>Rodapié</i>	10	-	17,73	1440	110x95x110
14.5x120 Riser/ <i>Tabica</i>	6	-	22,20	450	125x110x90

STEP
PELDAÑO



RECTO STEP
PELDAÑO RECTO
33x120
out in
C3 C1



RECTO STEP CORNER
PELDAÑO RECTO TAPA
33x120
out in
C3 C1

POOL EDGES
BORDES DE PISCINA



CRETA EDGE
BORDE CRETA
33x50x2.5
out
C3

DRAIN GRATES
REJILLAS DE DRENAJE



CERAMIC DRAIN GRATE
REJILLA DE DRENAJE CERÁMICA
RJ25 0000 25x50x2.2
out
C3

Drain - Desagüe: >13m³/hora
Grate rubber 9710 included
Goma p/rejilla 9710 incluida

ANTISHOCK Worldwide Patent
Patente Mundial



CERAMIC FLEX DRAIN GRATE
REJILLA DE DRENAJE CERÁMICA FLEX
RJ25 FLEX 25x50x2.2
out
C3

Drain - Desagüe: >30m³/hora
Grate rubber 9710 included
Goma p/rejilla 9710 incluida

ANTISHOCK Worldwide Patent
Patente Mundial



Component: Grate rubber
Componente: Goma p/Rejilla
Art. 9710

TRIM
PIEZAS TERMINACIÓN



Outer trim
Media caña exterior
MDCA E000 4.5x50



Scoth outer corner
Escocia cantonera exterior
MDCA EE000 4.5x4.5



Outer angle corner
Esquina cantonera exterior
MDCA AE000 6.5x6.5



External transition corner
Cantonera transición exterior
MDCA CE000 4.5x16



Inner trim
Media caña interior
MDCA I000 5.5x50



Scoth inner corner
Escocia cantonera interior
MDCA EI000 5.5x5.5



Inner angle corner
Esquina cantonera interior
MDCA AI000 6.5x6.5



Inner transition corner
Cantonera transición interior
MDCA CI000 5.5x16

*Detailed information about trim in pages 178 and 179

*Información detallada sobre las piezas de terminación en las páginas 178 y 179







CALACATTA FRESH





CALACATTA FRESH



COLLECTION *COLECCIÓN*

ETERNA

The unexpected beauty of the veins and chromatic variations
La belleza inusitada de los veteados y giros cromáticos

COLOURS
COLORES

ALBA



ARGENT



CENDRA



FORMATS
FORMATOS

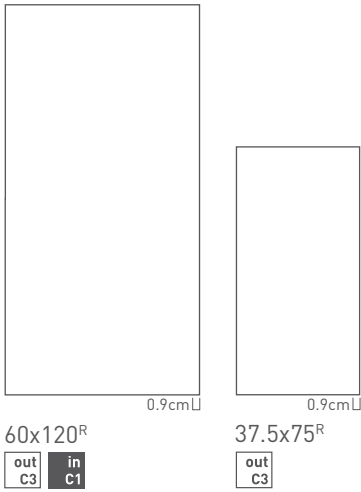

[^R] Rectified tiles - Bases rectificadas

OTHER FINISHES
OTROS ACABADOS



9x60
Skirting board
Rodapié



14.5x120
Riser
Tabica

PACKING
EMBALAJE

formats formatos	pieces / box piezas / caja	sqm / box m ² / caja	kg / box kg / caja	pieces / pallet piezas / palet	pallet sizes medidas palet
60x120 ^R	2	1,4400	30,00	72	120x84x74
37.5x75 ^R	4	1,1250	23,50	220	110x80x90
9x60 Skirting board/ <i>Rodapié</i>	10	-	17,73	1440	110x95x110
14.5x120 Riser/ <i>Tabica</i>	6	-	22,20	450	125x110x90

STEP
PELDAÑO



RECTO STEP
PELDAÑO RECTO
33x120



RECTO STEP CORNER
PELDAÑO RECTO TAPA
33x120















COLLECTION *COLECCIÓN*

STROMBOLI

A mediterranean feeling
Un sentimiento mediterráneo

COLOURS
COLORES

LIGHT



CREAM



SILVER



FORMATS
FORMATOS

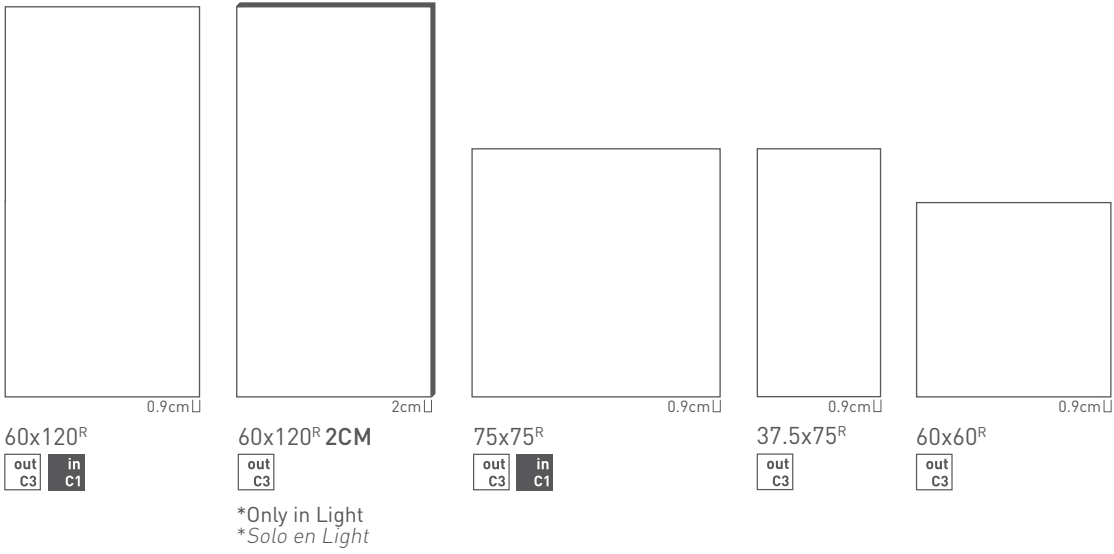

(^R) Rectified tiles - Bases rectificadas

OTHER FINISHES
OTROS ACABADOS

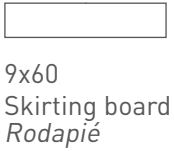

PACKING
EMBALAJE

formats formatos	pieces / box piezas / caja	sqm / box m ² / caja	kg / box kg / caja	pieces / pallet piezas / palet	pallet sizes medidas palet
60x120 ^R	2	1,4400	30,00	72	120x84x74
60x120 ^R 2CM	1	0,7200	34,37	27	120x84x74
75x75 ^R	2	1,1250	23,50	96	120x80x90
37.5x75 ^R	4	1,1250	23,50	220	110x80x90
60x60 ^R	4	1,4400	27,00	128	120x80x74
9x60 Skirting board/ <i>Rodapié</i>	10	-	17,73	1440	110x95x110
14.5x120 Riser/ <i>Tabica</i>	6	-	22,20	450	125x110x90

STEP
PELDAÑO



RECTO STEP
PELDAÑO RECTO
33x120
out in
C3 C1



RECTO STEP CORNER
PELDAÑO RECTO TAPA
33x120
out in
C3 C1



FULL STEP
PELDAÑO COMPLETO
33x120
out
C3



WINDOW SILL
VIERTAGUAS
18x50x3.2
out
C3

POOL EDGES
BORDES DE PISCINA



CRETA EDGE
BORDE CRETA
33x50x2.5
out
C3



SAMOA EDGE
BORDE SAMOA
50x120x2.5
out
C3

*Only in Light & Cream
*Solo en Light y Cream



MAUI EDGE
BORDE MAUI
33x50x2.5
out
C3



BORA EDGE
BORDE BORA
20x50x3.4
out
C3



CANARIAS SUPPORT EDGE
BORDE SOPORTE CANARIAS
18x50x3.4
out
C3



ARUBA EDGE
BORDE ARUBA
25x50x3.4
out
C3



MIKONOS EDGE
BORDE MIKONOS
45x70x3/3.5
out
C3

DRAIN GRATES
REJILLAS DE DRENAJE



CERAMIC DRAIN GRATE
REJILLA DE DRENAJE CERÁMICA
RJ20 0000 20x50x2.2



Drain - Desagüe: >11m³/hora
Grate rubber 9710 included
Goma p/rejilla 9710 incluida



CERAMIC FLEX DRAIN GRATE
REJILLA DE DRENAJE CERÁMICA FLEX
RJ20 FLEX 20x50x2.2



Drain - Desagüe: >30m³/hora
Grate rubber 9710 included
Goma p/rejilla 9710 incluida



CERAMIC DRAIN GRATE
REJILLA DE DRENAJE CERÁMICA
RJ25 0000 25x50x2.2



Drain - Desagüe: >13m³/hora
Grate rubber 9710 included
Goma p/rejilla 9710 incluida



CERAMIC FLEX DRAIN GRATE
REJILLA DE DRENAJE CERÁMICA FLEX
RJ25 FLEX 25x50x2.2



Drain - Desagüe: >30m³/hora
Grate rubber 9710 included
Goma p/rejilla 9710 incluida



Component: Grate rubber
Componente: Goma p/Rejilla
Art. 9710

TRIM
PIEZAS TERMINACIÓN



Outer trim
Media caña exterior
MDCA E000 4.5x50



Scoth outer corner
Escocia cantonera exterior
MDCA EE000 4.5x4.5



Outer angle corner
Esquina cantonera exterior
MDCA AE000 6.5x6.5



External transition corner
Cantonera transición exterior
MDCA CE000 4.5x16



Inner trim
Media caña interior
MDCA I000 5.5x50



Scoth inner corner
Escocia cantonera interior
MDCA EI000 5.5x5.5



Inner angle corner
Esquina cantonera interior
MDCA AI000 6.5x6.5



Inner transition corner
Cantonera transición interior
MDCA CI000 5.5x16

*Detailed information about trim in pages 178 and 179

*Información detallada sobre las piezas de terminación en las páginas 178 y 179





STROMBOLI LIGHT





STROMBOLI CREAM





STROMBOLI SILVER





STROMBOLI LIGHT



COLLECTION *COLECCIÓN*

CEMENTS

A uniform and pure style made for you
Un estilo uniforme y puro hecho para ti

COLOURS
COLORES

SNOW



WARM



SMOKE



FORMATS
FORMATOS

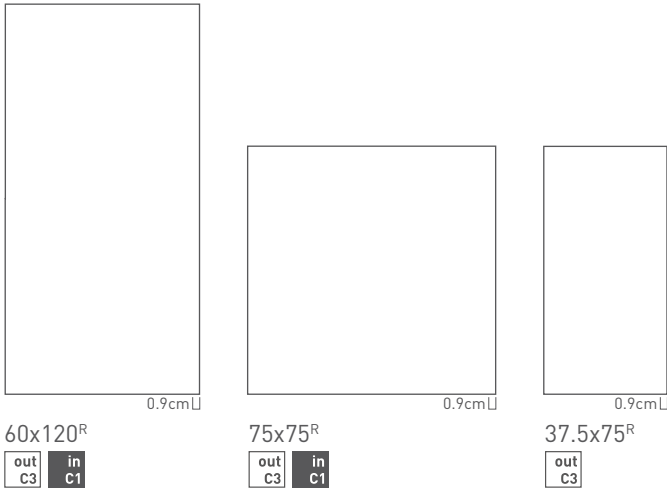

*Only in Snow
*Solo en Snow

[^R] Rectified tiles - Bases rectificadas

OTHER FINISHES
OTROS ACABADOS



9x60
Skirting board
Rodapié



14.5x120
Riser
Tabica

PACKING
EMBALAJE

formats formatos	pieces / box piezas / caja	sqm / box m ² / caja	kg / box kg / caja	pieces / pallet piezas / palet	pallet sizes medidas palet
60x120 ^R	2	1,4400	30,00	72	120x84x74
75x75 ^R	2	1,1250	23,50	96	120x80x90
37.5x75 ^R	4	1,1250	23,50	220	120x80x89
9x60 Skirting board/ <i>Rodapié</i>	10	-	17,73	1440	110x95x110
14.5x120 Riser/ <i>Tabica</i>	6	-	22,20	450	125x110x90

STEP
PELDAÑO



RECTO STEP
PELDAÑO RECTO
33x120
out in
C3 C1



RECTO STEP CORNER
PELDAÑO RECTO TAPA
33x120
out in
C3 C1

POOL EDGES
BORDES DE PISCINA



CRETA EDGE
BORDE CRETA
33x50x2.5
out
C3

DRAIN GRATES
REJILLAS DE DRENAJE



CERAMIC DRAIN GRATE
REJILLA DE DRENAJE CERÁMICA
RJ25 0000 25x50x2.2
out
C3
Drain - Desagüe: >13m³/hora
Grate rubber 9710 included
Goma p/rejilla 9710 incluida
ANTISHOCK Worldwide Patent
Patente Mundial



CERAMIC FLEX DRAIN GRATE
REJILLA DE DRENAJE CERÁMICA FLEX
RJ25 FLEX 25x50x2.2
out
C3
Drain - Desagüe: >30m³/hora
Grate rubber 9710 included
Goma p/rejilla 9710 incluida
ANTISHOCK Worldwide Patent
Patente Mundial



Component: Grate rubber
Componente: Goma p/Rejilla
Art. 9710

TRIM
PIEZAS TERMINACIÓN



Outer trim
Media caña exterior
MDCA E000 4.5x50



Scoth outer corner
Escocia cantonera exterior
MDCA EE000 4.5x4.5



Outer angle corner
Esquina cantonera exterior
MDCA AE000 6.5x6.5



External transition corner
Cantonera transición exterior
MDCA CE000 4.5x16



Inner trim
Media caña interior
MDCA I000 5.5x50



Scoth inner corner
Escocia cantonera interior
MDCA EI000 5.5x5.5



Inner angle corner
Esquina cantonera interior
MDCA AI000 6.5x6.5



Inner transition corner
Cantonera transición interior
MDCA CI000 5.5x16

*Detailed information about trim in pages 178 and 179
*Información detallada sobre las piezas de terminación en las páginas 178 y 179











CEMENTS SNOW



COLLECTION *COLECCIÓN*

AMAZONIA

For those who want to stand out
Para los que quieren marcar la diferencia

COLOURS
COLORES

MIEL



CANELA



FORMATS
FORMATOS

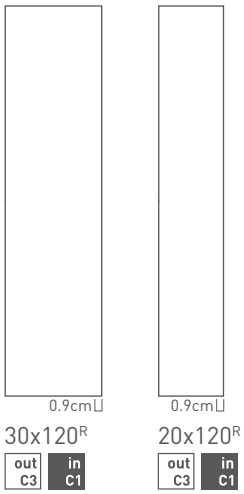

(^R) Rectified tiles - Bases rectificadas

OTHER FINISHES
OTROS ACABADOS



9x60
Skirting board
Rodapié



14.5x120
Riser
Tabica

PACKING
EMBALAJE

formats formatos	pieces / box piezas / caja	sqm / box m ² / caja	kg / box kg / caja	pieces / pallet piezas / palet	pallet sizes medidas palet
30x120 ^R	4	1,4400	32,00	144	120x80x74
20x120 ^R	5	1,2000	23,50	225	120x80x83
9x60 Skirting board/ <i>Rodapié</i>	10	-	17,73	1440	110x95x110
14.5x120 Riser/ <i>Tabica</i>	6	-	22,20	450	125x110x90

STEP
PELDAÑO



RECTO STEP
PELDAÑO RECTO
33x120

out	in
C3	C1



RECTO STEP CORNER
PELDAÑO RECTO TAPA
33x120

out	in
C3	C1







AMAZONIA CANELA





AMAZONIA MIEL



COLLECTION *COLECCIÓN*

WOODS

The most versatile wood
La madera más versátil

COLOURS
COLORES

ARCTIC



NORDIC



OLIVO



FORMATS

FORMATOS



0,9cmL

20x120^R

out	in
C3	C1

[^R] Rectified tiles - Bases rectificadas

OTHER FINISHES

OTROS ACABADOS



9x60

Skirting board
Rodapié

14.5x120

Riser
Tabica

PACKING

EMBALAJE

formats formatos	pieces / box piezas / caja	sqm / box m ² / caja	kg / box kg / caja	pieces / pallet piezas / palet	pallet sizes medidas palet
20x120 ^R	5	1,2000	23,50	225	120x80x83
9x60 Skirting board/ <i>Rodapié</i>	10	-	17,73	1440	110x95x110
14.5x120 Riser/ <i>Tabica</i>	6	-	22,20	450	125x110x90

STEP
PELDAÑO



RECTO STEP
PELDAÑO RECTO
33x120
out in
C3 C1



RECTO STEP CORNER
PELDAÑO RECTO TAPA
33x120
out in
C3 C1



FULL STEP
PELDAÑO COMPLETO
33x120
out
C3



WINDOW SILL
VIERTAGUAS
18x50x3.2
out
C3

POOL EDGES
BORDES DE PISCINA



CRETA EDGE
BORDE CRETA
33x50x2.5
out
C3

DRAIN GRATES
REJILLAS DE DRENAJE



CERAMIC DRAIN GRATE
REJILLA DE DRENAJE CERÁMICA
RJ25 0000 25x50x2.2
out
C3

Drain - Desagüe: >13m³/hora
Grate rubber 9710 included
Goma p/rejilla 9710 incluida

ANTISHOCK Worldwide Patent
Patente Mundial



CERAMIC FLEX DRAIN GRATE
REJILLA DE DRENAJE CERÁMICA FLEX
RJ25 FLEX 25x50x2.2
out
C3

Drain - Desagüe: >30m³/hora
Grate rubber 9710 included
Goma p/rejilla 9710 incluida

ANTISHOCK Worldwide Patent
Patente Mundial



Component: Grate rubber
Componente: Goma p/Rejilla
Art. 9710

TRIM*PIEZAS TERMINACIÓN*

Outer trim
Media caña exterior
 MDCA E000 4.5x50



Scotch outer corner
Escocia cantonera exterior
 MDCA EE000 4.5x4.5



Outer angle corner
Esquina cantonera exterior
 MDCA AE000 6.5x6.5



External transition corner
Cantonera transición exterior
 MDCA CE000 4.5x16



Inner trim
Media caña interior
 MDCA I000 5.5x50



Scotch inner corner
Escocia cantonera interior
 MDCA EI000 5.5x5.5



Inner angle corner
Esquina cantonera interior
 MDCA AI000 6.5x6.5



Inner transition corner
Cantonera transición interior
 MDCA CI000 5.5x16

*Detailed information about trim in pages 178 and 179

*Información detallada sobre las piezas de terminación en las páginas 178 y 179

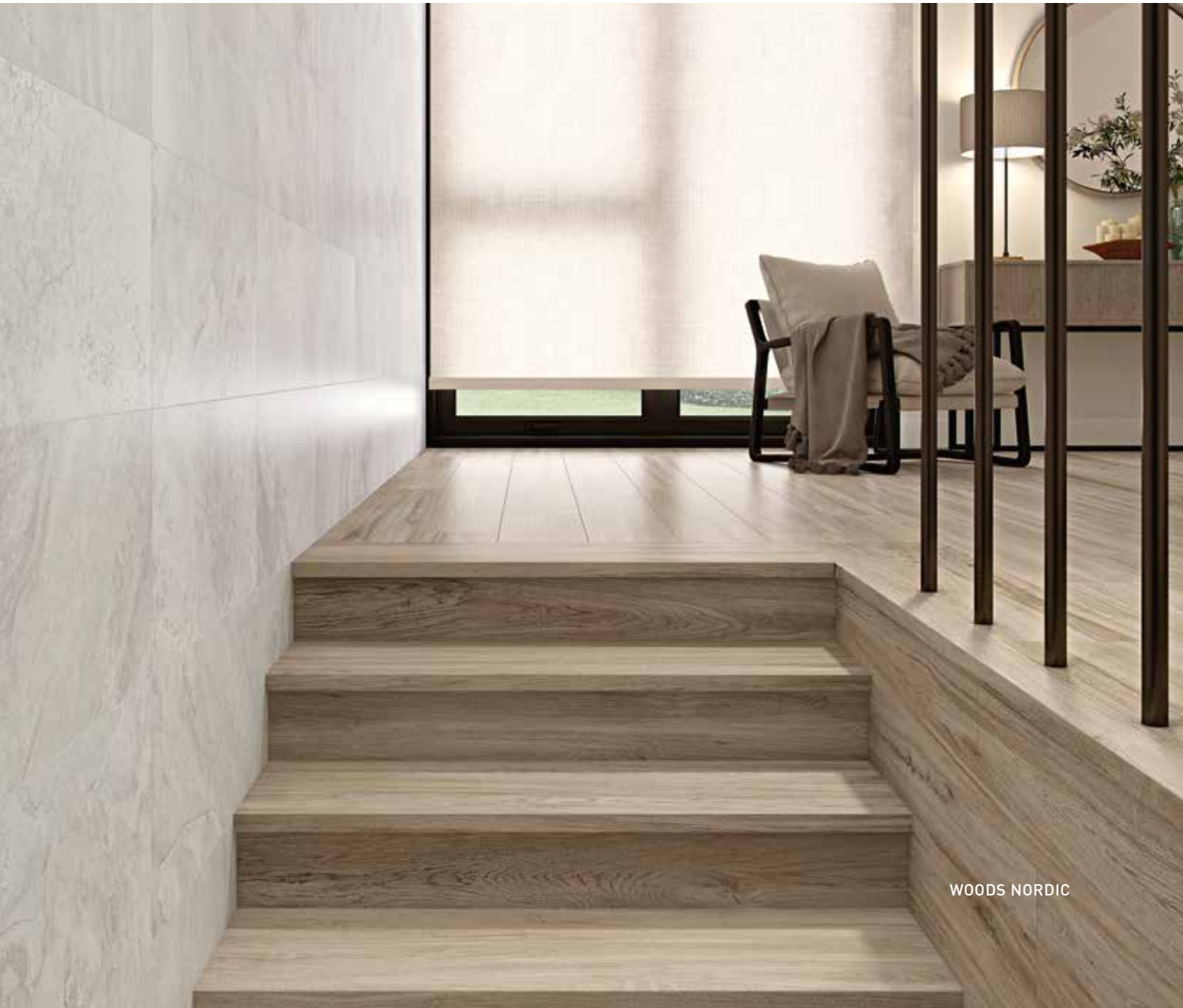









WOODS ARCTIC



COLLECTION *COLECCIÓN*

SEA ROCK

Born from the sea rocks
Nacida de las rocas marinas

COLOURS
COLORES

MARFIL



CARMEL



FORMATS
FORMATOS

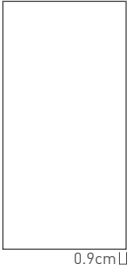

37.5x75^R



[^R] Rectified tiles - Bases rectificadas

OTHER FINISHES
OTROS ACABADOS



9x60
Skirting board
Rodapié



14.5x120
Riser
Tabica

PACKING
EMBALAJE

formats formatos	pieces / box piezas / caja	sqm / box m ² / caja	kg / box kg / caja	pieces / pallet piezas / palet	pallet sizes medidas palet
37.5x75 ^R	4	1,1250	23,50	220	120x80x89
9x60 Skirting board/ <i>Rodapié</i>	10	-	17,73	1440	110x95x110
14.5x120 Riser/ <i>Tabica</i>	6	-	22,20	450	125x110x90

STEP
PELDAÑO



RECTO STEP
PELDAÑO RECTO
33x120

out
C3



RECTO STEP CORNER
PELDAÑO RECTO TAPA
33x120

out
C3



FULL STEP
PELDAÑO COMPLETO
33x120

out
C3



WINDOW SILL
VIERTAGUAS
18x50x3.2

out
C3



SEA ROCK MARFIL



COLLECTION *COLECCIÓN*

TROPIC

Your own tropical paradise
Tu propio paraíso tropical

COLOURS
COLORES

TURQUETA



out
C3



in
C1

AGUAMARINA



out
C3



in
C1

FORMATS
FORMATOS

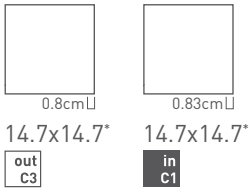

(*) Not rectified tiles - Bases sin rectificar

PACKING
EMBALAJE

formats formatos	pieces / box piezas / caja	sqm / box m ² / caja	kg / box kg / caja	pieces / pallet piezas / palet	pallet sizes medidas palet
14.7x14.7* - in	42	0,9076	16,20	3360	120x80x89
14.7x14.7* - out	44	0,9508	16,97	3520	120x80x89

TRIM
PIEZAS TERMINACIÓN



Outer trim
Media caña exterior
MDCA E000 4.5x50



Scoth outer corner
Escocia cantonera exterior
MDCA EE000 4.5x4.5



Outer angle corner
Esquina cantonera exterior
MDCA AE000 6.5x6.5



External transition corner
Cantonera transición exterior
MDCA CE000 4.5x16



Inner trim
Media caña interior
MDCA I000 5.5x50



Scoth inner corner
Escocia cantonera interior
MDCA EI000 5.5x5.5



Inner angle corner
Esquina cantonera interior
MDCA AI000 6.5x6.5



Inner transition corner
Cantonera transición interior
MDCA CI000 5.5x16



*Detailed information about trim in pages 178 and 179

*Información detallada sobre las piezas de terminación en las páginas 178 y 179





TROPIC TURQUETA





TROPIC TURQUETA

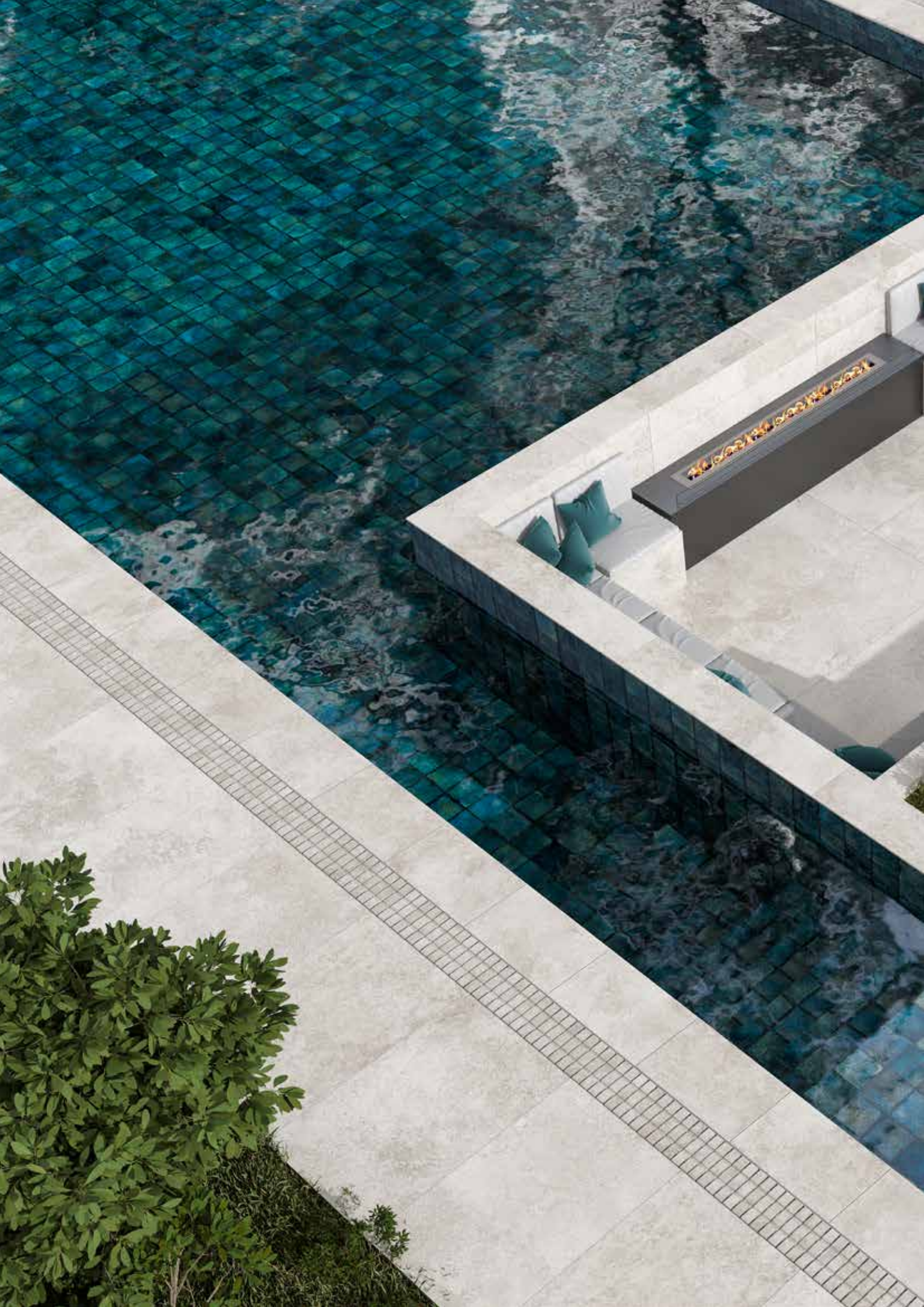



TROPIC AGUAMARINA



COLLECTION *COLECCIÓN*

BALI

The art of natural stone
El arte de la piedra natural

COLOURS
COLORES

ZATU



FORMATS

FORMATOS



0.8cmL

14.7x14.7*

out
c3

(*) Not rectified tiles - Bases sin rectificar

PACKING

EMBALAJE

formats formatos	pieces / box piezas / caja	sqm / box m ² / caja	kg / box kg / caja	pieces / pallet piezas / palet	pallet sizes medidas palet
14.7x14.7*	44	0,9508	16,97	3520	120x80x89

TRIM

PIEZAS TERMINACIÓN



Outer trim
Media caña exterior
MDCA E000 4.5x50



Scoth outer corner
Escocia cantonera exterior
MDCA EE000 4.5x4.5



Outer angle corner
Esquina cantonera exterior
MDCA AE000 6.5x6.5



External transition corner
Cantonera transición exterior
MDCA CE000 4.5x16



Inner trim
Media caña interior
MDCA I000 5.5x50



Scoth inner corner
Escocia cantonera interior
MDCA EI000 5.5x5.5



Inner angle corner
Esquina cantonera interior
MDCA AI000 6.5x6.5



Inner transition corner
Cantonera transición interior
MDCA CI000 5.5x16

*Detailed information about trim in pages 178 and 179

*Información detallada sobre las piezas de terminación en las páginas 178 y 179









POOL SOLUTIONS

CONSTRUCTIVE SOLUTIONS FOR THE POOL SHELL
SOLUCIONES CONSTRUCTIVAS PARA EL VASO DE LA PISCINA

CRETA

BASIC SYSTEM PIECES SISTEMA BÁSICO DE PIEZAS



CRETA EDGE
BORDE CRETA
BPCR 0000 33x50

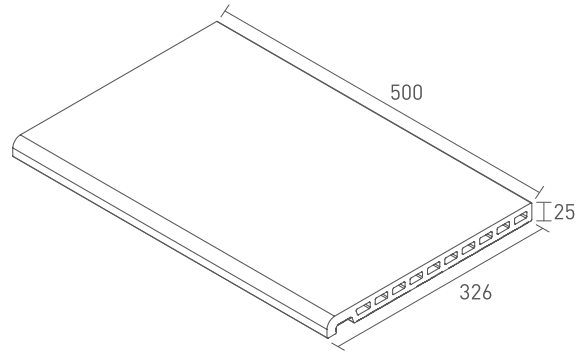
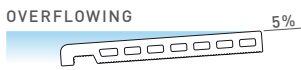

Enamelled on 3 sides
Esmaltado a 3 caras

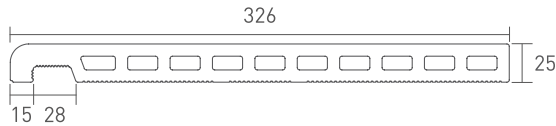

AVAILABLE COLOURS COLORES DISPONIBLES



Salem CLAR



Stromboli LIGHT



Woods ARCTIC



Cupira HUESO



Lao BONE



Cements SNOW



Calacatta FRESH



Stromboli CREAM



Woods NORDIC



Cupira MULTI



Lao SAND



Cements WARM



Crosscut PETRA



Stromboli SILVER



Woods OLIVO



Cupira MARENGO



Lao ASH



Cements SMOKE



Crosscut CLOUD

CURVED SOLUTION
SOLUCIÓN CURVA

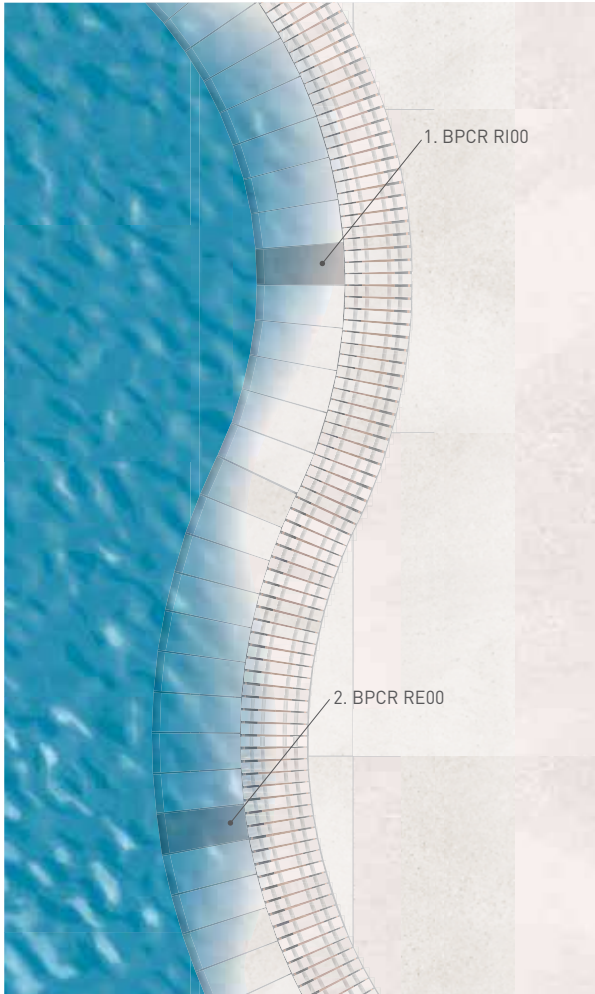

CRETA CURVED EDGE

BORDE CURVO CRETA

- ① BPCR RI00
- ② BPCR RE00

Can be used with drain grates RJ25, RJ25 FLEX, RJ20 and RJ20 FLEX

Compatible con las rejillas RJ25, RJ25 FLEX, RJ20 y RJ20 FLEX

CORNER SOLUTION
SOLUCIÓN ESQUINA

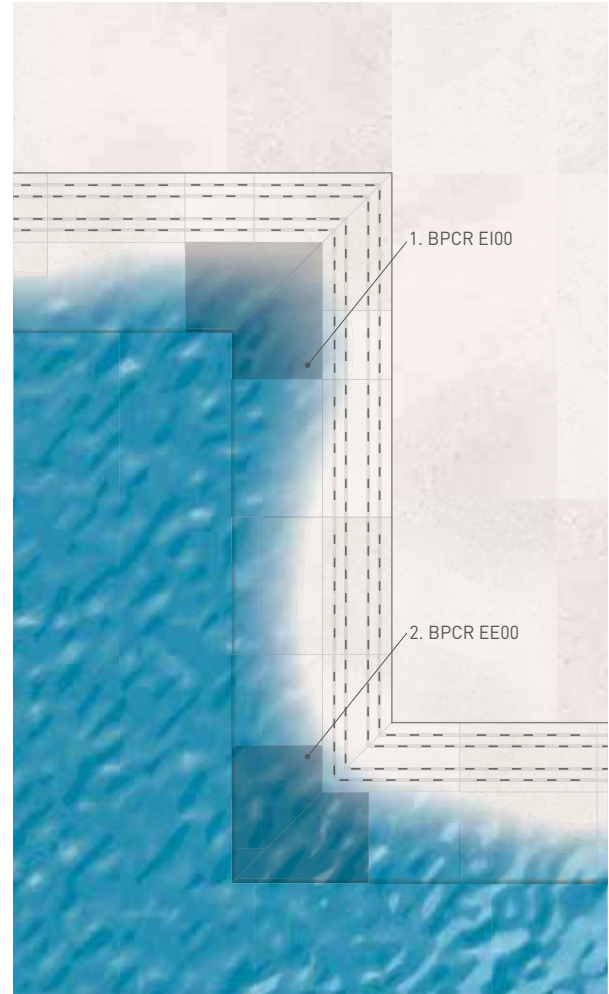

CRETA EDGE CORNER PACK (2pcs)

PACK ESQUINA BORDE CRETA (2pcs)

- ① BPCR EI00 33x50
- ② BPCR EE00 33x50

Can be used with drain grates RJ25, RJ25 FLEX, RJ20 and RJ20 FLEX

Compatible con las rejillas RJ25, RJ25 FLEX, RJ20 y RJ20 FLEX

TECHNICAL INFORMATION
INFORMACIÓN TÉCNICA

MONOBLOCK ONE PIECE, WITHOUT GLUED
UNA PIEZA, SIN PEGADO



UNE 41901
CLASE 3



EN ISO 10545-12
✓



DIN 51130
R11



DIN 51097
CLASE C



EN ISO 10545-13
GA / GLA / GHA



LONG LIFE
LARGA VIDA



EASY CLEAN
FÁCIL LIMPIEZA





CUPIRA MULTI , STROMBOLI LIGHT & CRETA

SAMOA

BASIC SYSTEM PIECES SISTEMA BÁSICO DE PIEZAS



SAMOA EDGE
BORDE SAMOA
BPSA 0000 50x120

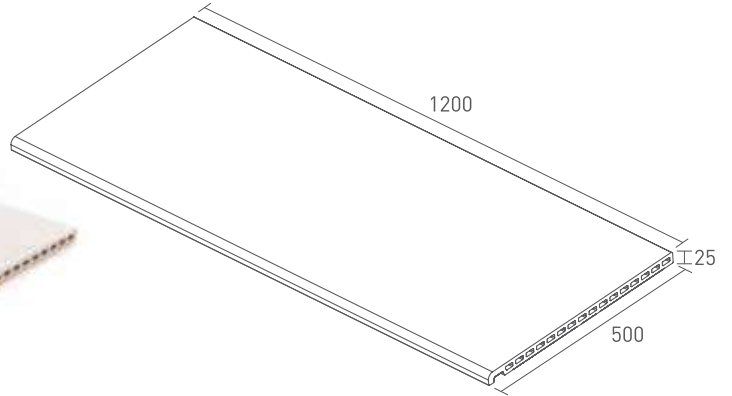

Enamelled on 3 sides
Esmaltado a 3 caras

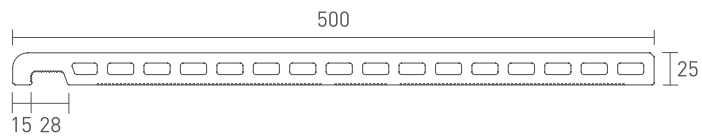

AVAILABLE COLOURS COLORES DISPONIBLES



Stromboli LIGHT



Stromboli CREAM



Lao BONE



Lao SAND



Lao ASH



Crosscut PETRA



Crosscut CLOUD



Salem CLAR

CURVED SOLUTION
SOLUCIÓN CURVA

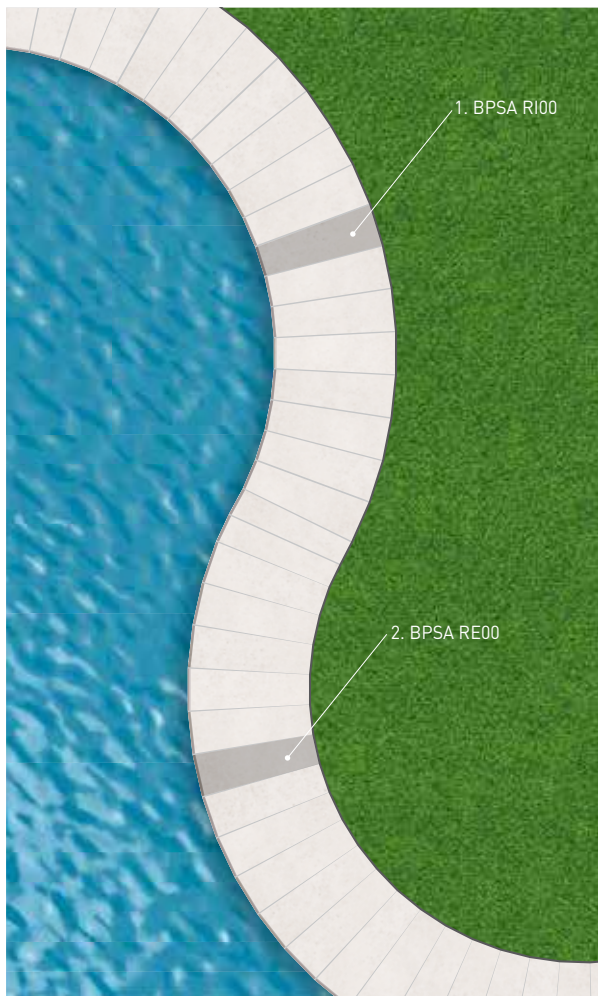

SAMOA CURVED EDGE
BORDE CURVO SAMOA

- ① BPSA RI00
- ② BPSA RE00

CORNER SOLUTION
SOLUCIÓN ESQUINA

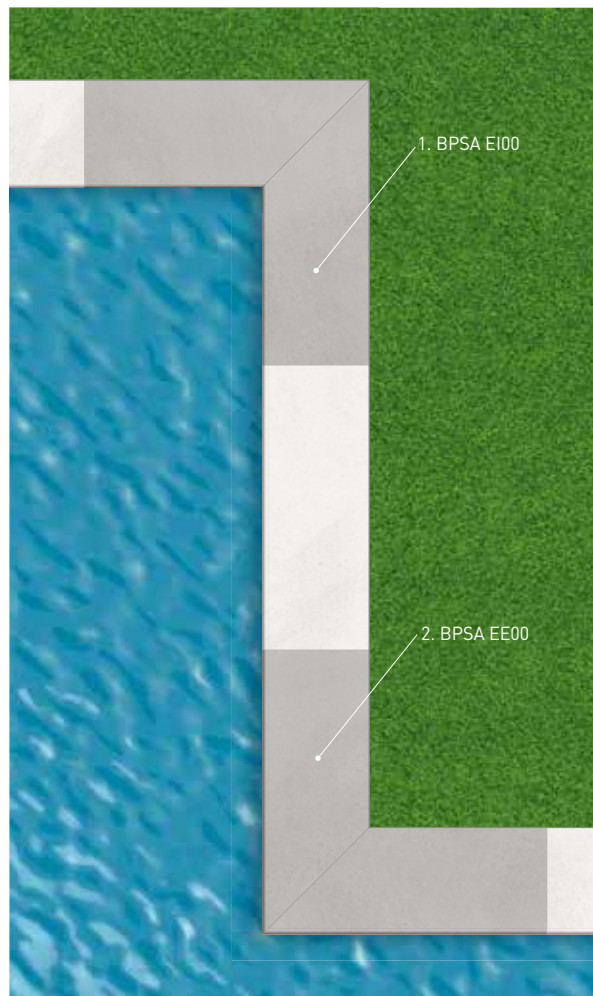

SAMOA EDGE CORNER PACK (2pcs)
PACK ESQUINA BORDE SAMOA (2pcs)

- ① BPSA EI00 50x120
- ② BPSA EE00 50x120

TECHNICAL INFORMATION
INFORMACIÓN TÉCNICA

MONOBLOCK ONE PIECE, WITHOUT GLUED
UNA PIEZA, SIN PEGADO



UNE 41901
CLASE 3



EN ISO 10545-12
✓



DIN 51130
R11



DIN 51097
CLASE C



EN ISO 10545-13
GA / GLA / GHA



LONG LIFE
LARGA VIDA



EASY CLEAN
FÁCIL LIMPIEZA



CROSSCUT CLOUD & SAMOA



STROMBOLI LIGHT & SAMOA

MAUI

BASIC SYSTEM PIECES SISTEMA BÁSICO DE PIEZAS



MAUI EDGE
BORDE MAUI
BPMA 0000 33x50

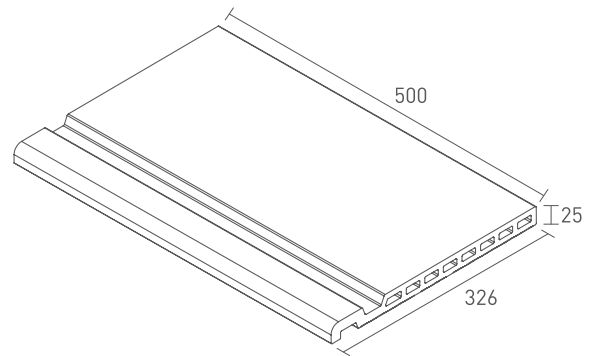

Enamelled on 3 sides
Esmaltado a 3 caras



AVAILABLE COLOURS COLORES DISPONIBLES



Lao BONE



Lao SAND



Lao ASH



Salem CLAR



Stromboli LIGHT



Stromboli CREAM



Stromboli SILVER



Crosscut PETRA



Crosscut CLOUD

CURVED SOLUTION
SOLUCIÓN CURVA

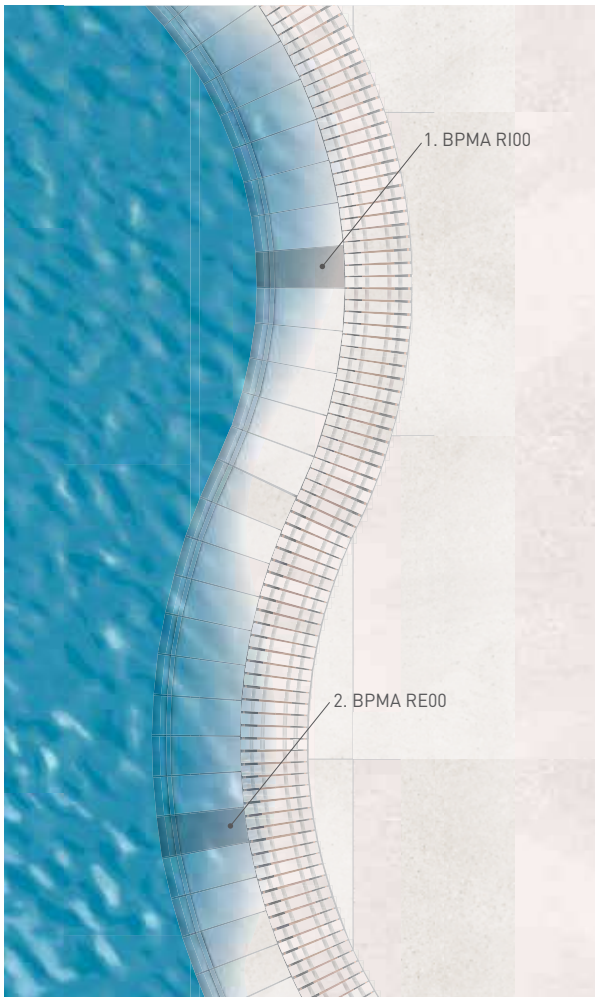

MAUI CURVED EDGE

BORDE CURVO MAUI

- ① BPMA RI00
- ② BPMA RE00

Can be used with drain grates RJ25, RJ25 FLEX, RJ20 and RJ20 FLEX

Compatible con las rejillas RJ25, RJ25 FLEX, RJ20 y RJ20 FLEX

CORNER SOLUTION
SOLUCIÓN ESQUINA

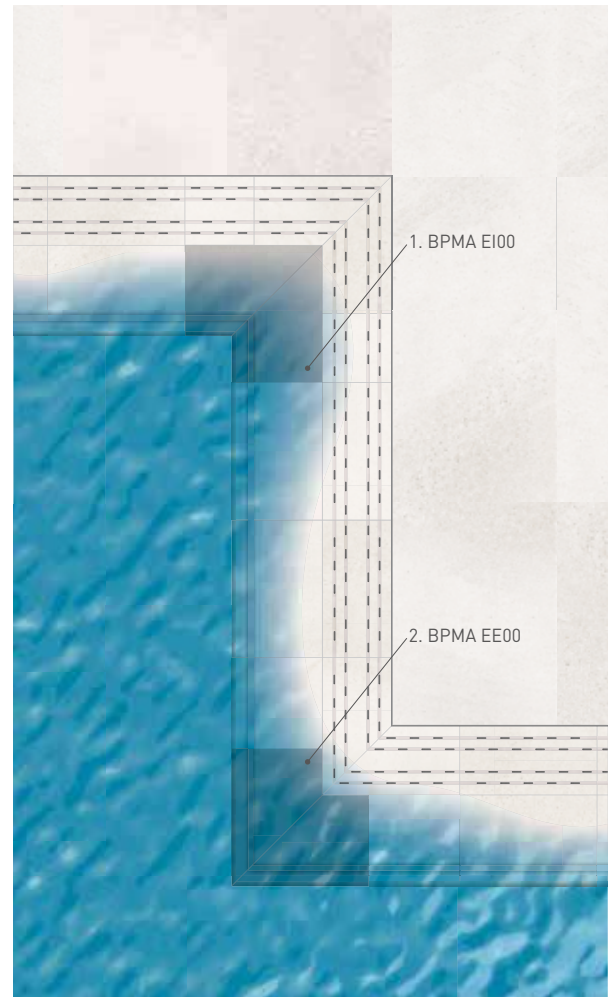

MAUI EDGE CORNER PACK (2pcs)

PACK ESQUINA BORDE MAUI (2pcs)

- ① BPMA EI00 33x50
- ② BPMA EE00 33x50

Can be used with drain grates RJ25, RJ25 FLEX, RJ20 and RJ20 FLEX

Compatible con las rejillas RJ25, RJ25 FLEX, RJ20 y RJ20 FLEX

TECHNICAL INFORMATION
INFORMACIÓN TÉCNICA

MONOBLOCK ONE PIECE, WITHOUT GLUED
UNA PIEZA, SIN PEGADO



UNE 41901
CLASE 3



EN ISO 10545-12
✓



DIN 51130
R11



DIN 51097
CLASE C



EN ISO 10545-13
GA / GLA / GHA



LONG LIFE
LARGA VIDA



EASY CLEAN
FÁCIL LIMPIEZA





STROMBOLI CREAM & MAUI

MIKONOS

BASIC SYSTEM PIECES

SISTEMA BÁSICO DE PIEZAS



MIKONOS EDGE
BORDE MIKONOS
BPMI 0000 45x70

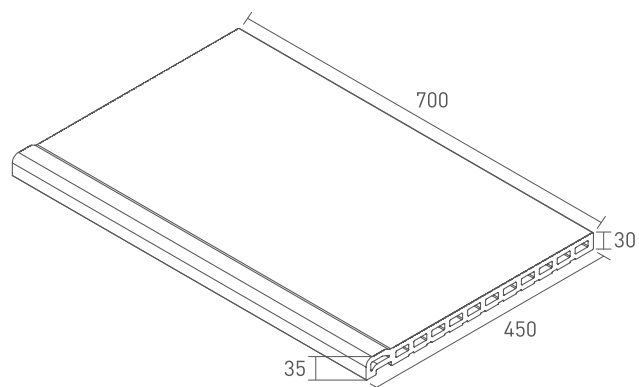

Enamelled on 3 sides
Esmaltado a 3 caras

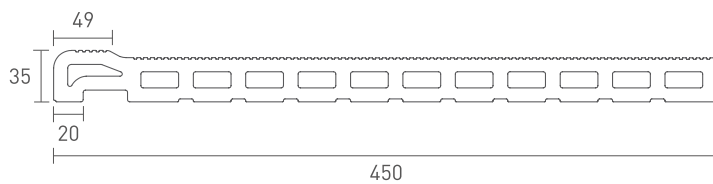

AVAILABLE COLOURS

COLORES DISPONIBLES

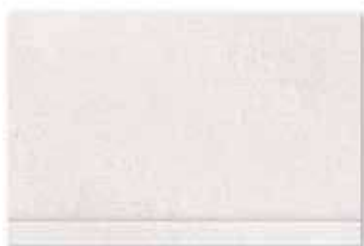

Stromboli LIGHT



Stromboli CREAM



Stromboli SILVER

CURVED SOLUTION
SOLUCIÓN CURVA

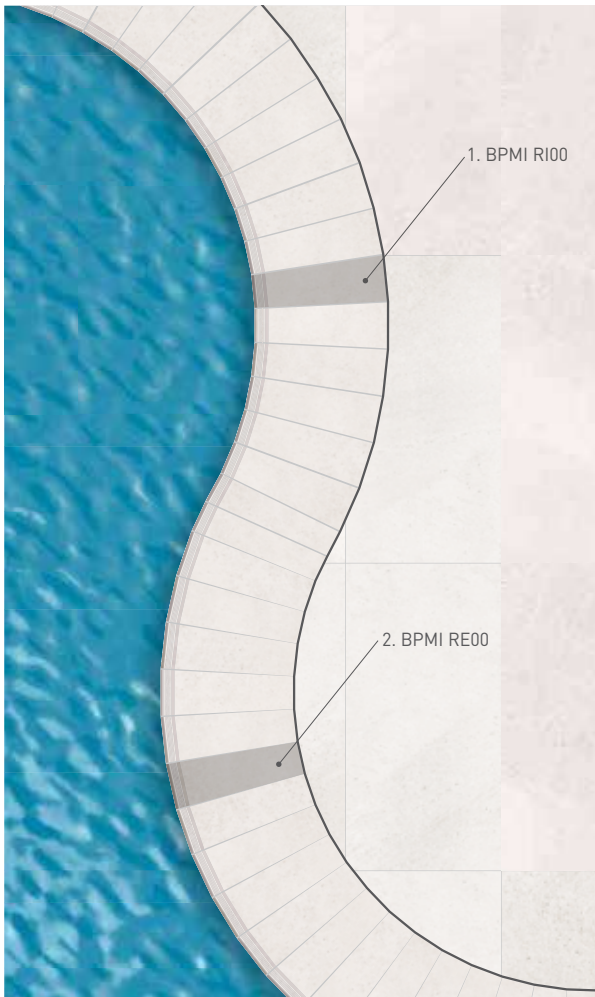

MIKONOS CURVED EDGE
BORDE CURVO MIKONOS
① BPMI RI00
② BPMI RE00

CORNER SOLUTION
SOLUCIÓN ESQUINA

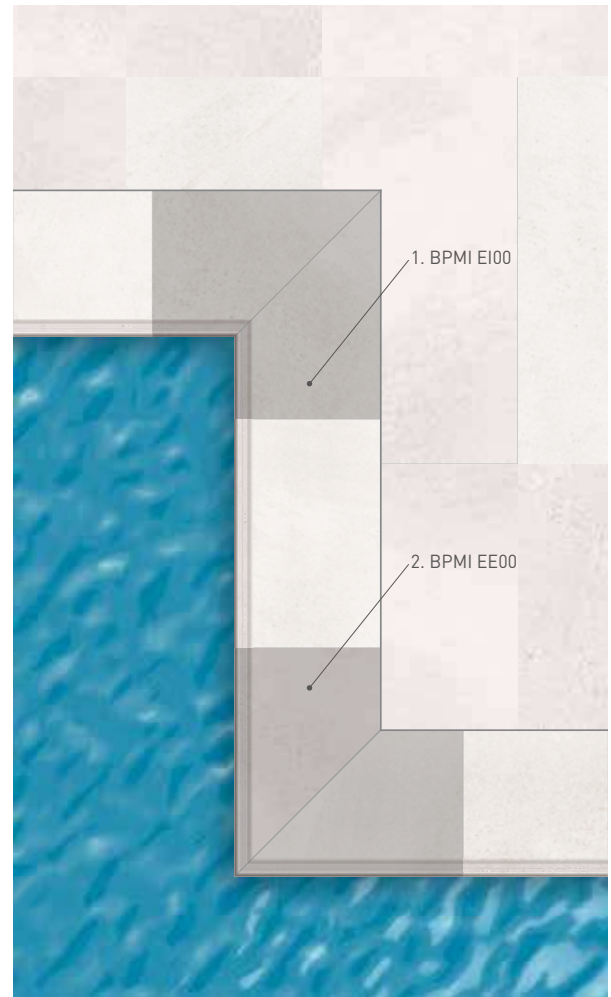

MIKONOS EDGE CORNER PACK (2pcs)
PACK ESQUINA BORDE MIKONOS (2pcs)
① BPMI EI00 45x70
② BPMI EE00 45x70

TECHNICAL INFORMATION
INFORMACIÓN TÉCNICA

MONOBLOCK ONE PIECE, WITHOUT GLUED
UNA PIEZA, SIN PEGADO



UNE 41901
CLASE 3



EN ISO 10545-12
✓



DIN 51130
R12



DIN 51097
CLASE C



EN ISO 10545-13
GA / GLA / GHA



LONG LIFE
LARGA VIDA



EASY CLEAN
FÁCIL LIMPIEZA





STROMBOLI LIGHT & MIKON05

BORA

BASIC SYSTEM PIECES SISTEMA BÁSICO DE PIEZAS



BORA EDGE
BORDE BORA
BPBO 0000 20x50

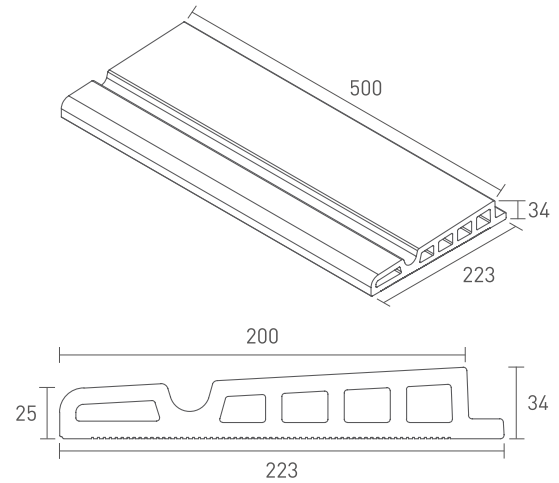

GRATE SUPPORT
SOPORTE PARA REJILLA
BSCA 0000 18x50

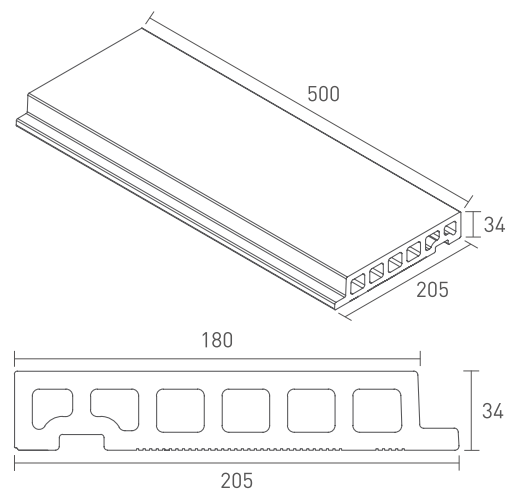

AVAILABLE COLOURS COLORES DISPONIBLES



Stromboli LIGHT



Stromboli CREAM



Stromboli SILVER



Crosscut PETRA



Crosscut CLOUD

CURVED SOLUTION
SOLUCIÓN CURVA

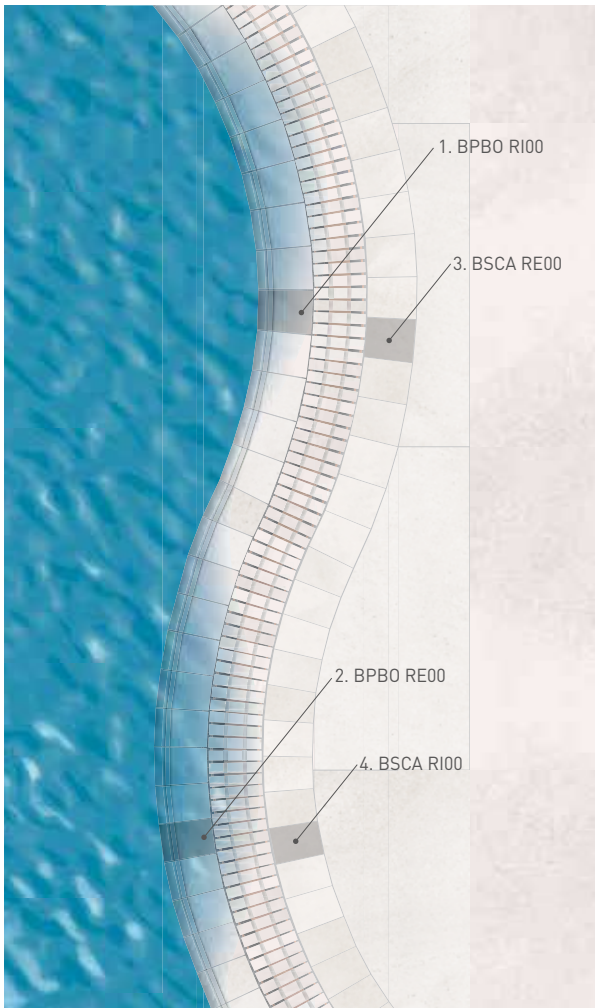

BORA CURVED EDGE

BORDE CURVO BORA

- ① BPBO RI00
- ② BPBO RE00

CANARIAS CURVED GRATE SUPPORT

SOPORTE CURVO CANARIAS PARA REJILLA

- ③ BSCA RE00
- ④ BSCA RI00

Both can be used with drain grates RJ25, RJ25 FLEX, RJ20 and RJ20 FLEX

Ambos son compatibles con las rejillas RJ25, RJ25 FLEX, RJ20 y RJ20 FLEX

CORNER SOLUTION
SOLUCIÓN ESQUINA

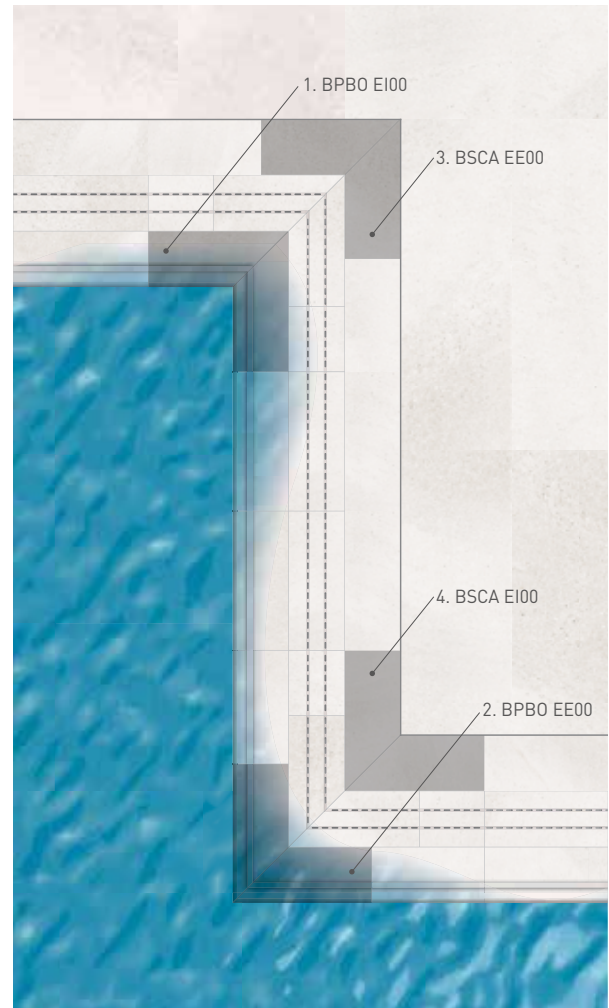

BORA EDGE CORNER PACK (2pcs)

PACK ESQUINA BORDE BORA (2pcs)

- ① BPBO EI00 20x_
- ② BPBO EE00 20x_

CANARIAS CORNER GRATE SUPPORT PACK (2pcs)

PACK SOPORTE ESQUINA CANARIAS PARA REJILLA (2pcs)

- ③ BSCA EE00 18x50
- ④ BSCA EI00 18x50

Both can be used with drain grates RJ25, RJ25 FLEX, RJ20 and RJ20 FLEX

Ambos son compatibles con las rejillas RJ25, RJ25 FLEX, RJ20 y RJ20 FLEX

TECHNICAL INFORMATION
INFORMACIÓN TÉCNICA

MONOBLOCK ONE PIECE, WITHOUT GLUED
UNA PIEZA, SIN PEGADO



UNE 41901
CLASE 3



EN ISO 10545-12
✓



DIN 51130
R11



DIN 51097
CLASE C



EN ISO 10545-13
GA / GLA / GHA



LONG LIFE
LARGA VIDA



EASY CLEAN
FÁCIL LIMPIEZA





CANARIAS

BASIC SYSTEM PIECES

SISTEMA BÁSICO DE PIEZAS



CANARIAS EDGE
BORDE CANARIAS
BSCA 0000 18x50

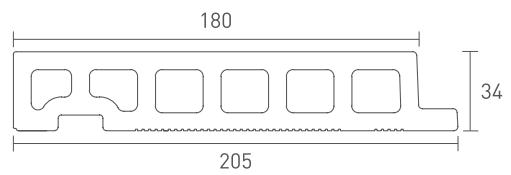
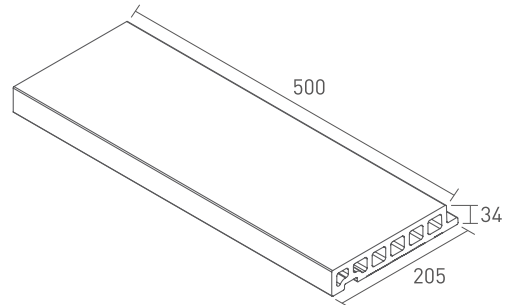

GRATE SUPPORT
SOPORTE PARA REJILLA
BSCA 0000 18x50

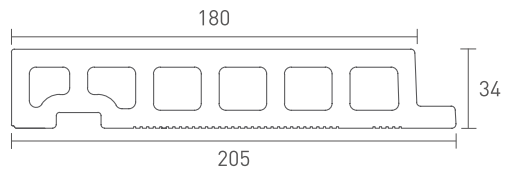
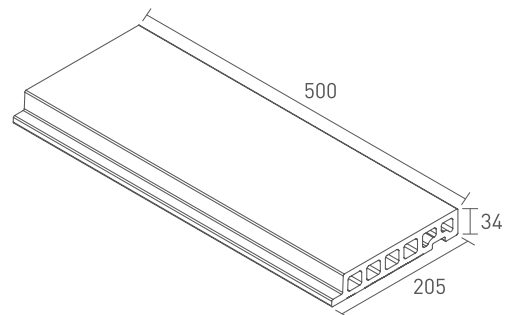

AVAILABLE COLOURS

COLORES DISPONIBLES



Stromboli LIGHT



Stromboli CREAM



Stromboli SILVER



Crosscut PETRA



Crosscut CLOUD

CURVED SOLUTION
SOLUCIÓN CURVA

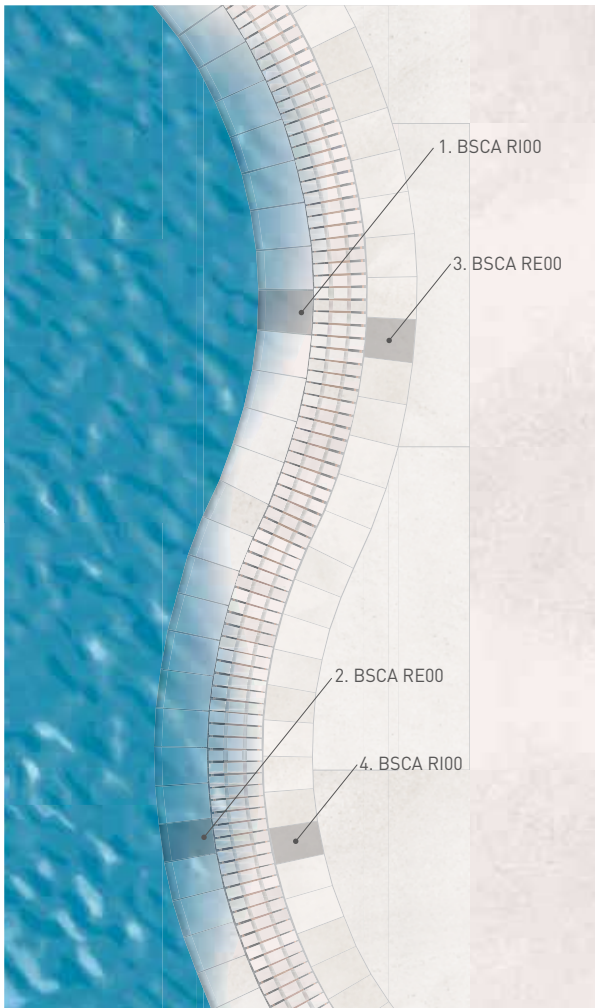

CANARIAS CURVED EDGE

BORDE CURVO CANARIAS

- ① BSCA RI00
- ② BSCA RE00

CANARIAS CURVED GRATE SUPPORT

SOPORTE CURVO CANARIAS PARA REJILLA

- ③ BSCA RE00
- ④ BSCA RI00

Both can be used with drain grates RJ25, RJ25 FLEX, RJ20 and RJ20 FLEX

Ambos son compatibles con las rejillas RJ25, RJ25 FLEX, RJ20 y RJ20 FLEX

CORNER SOLUTION
SOLUCIÓN ESQUINA

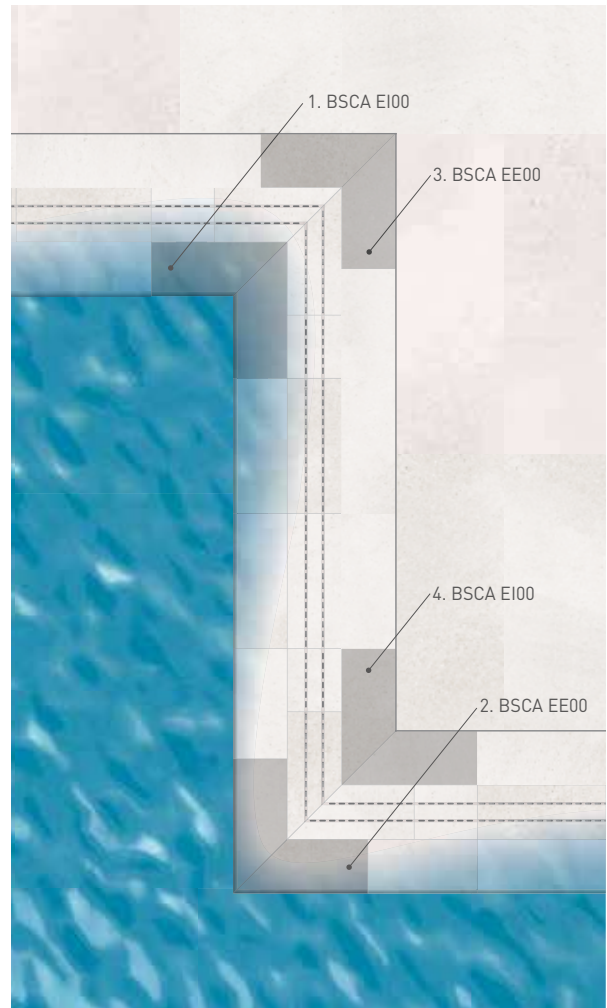

CANARIAS EDGE CORNER PACK (2pcs)

PACK ESQUINA BORDE CANARIAS (2pcs)

- ① BSCA EI00 20x_
- ② BSCA EE00 20x_

CANARIAS CORNER GRATE SUPPORT PACK (2pcs)

PACK SOPORTE ESQUINA CANARIAS PARA REJILLA (2pcs)

- ③ BSCA EE00 18x50
- ④ BSCA EI00 18x50

Both can be used with drain grates RJ25, RJ25 FLEX, RJ20 and RJ20 FLEX

Ambos son compatibles con las rejillas RJ25, RJ25 FLEX, RJ20 y RJ20 FLEX

TECHNICAL INFORMATION

INFORMACIÓN TÉCNICA

MONOBLOCK ONE PIECE, WITHOUT GLUED
UNA PIEZA, SIN PEGADO



UNE 41901
CLASE 3



EN ISO 10545-12
✓



DIN 51130
R11



DIN 51097
CLASE C



EN ISO 10545-13
GA / GLA / GHA



LONG LIFE
LARGA VIDA



EASY CLEAN
FÁCIL LIMPIEZA

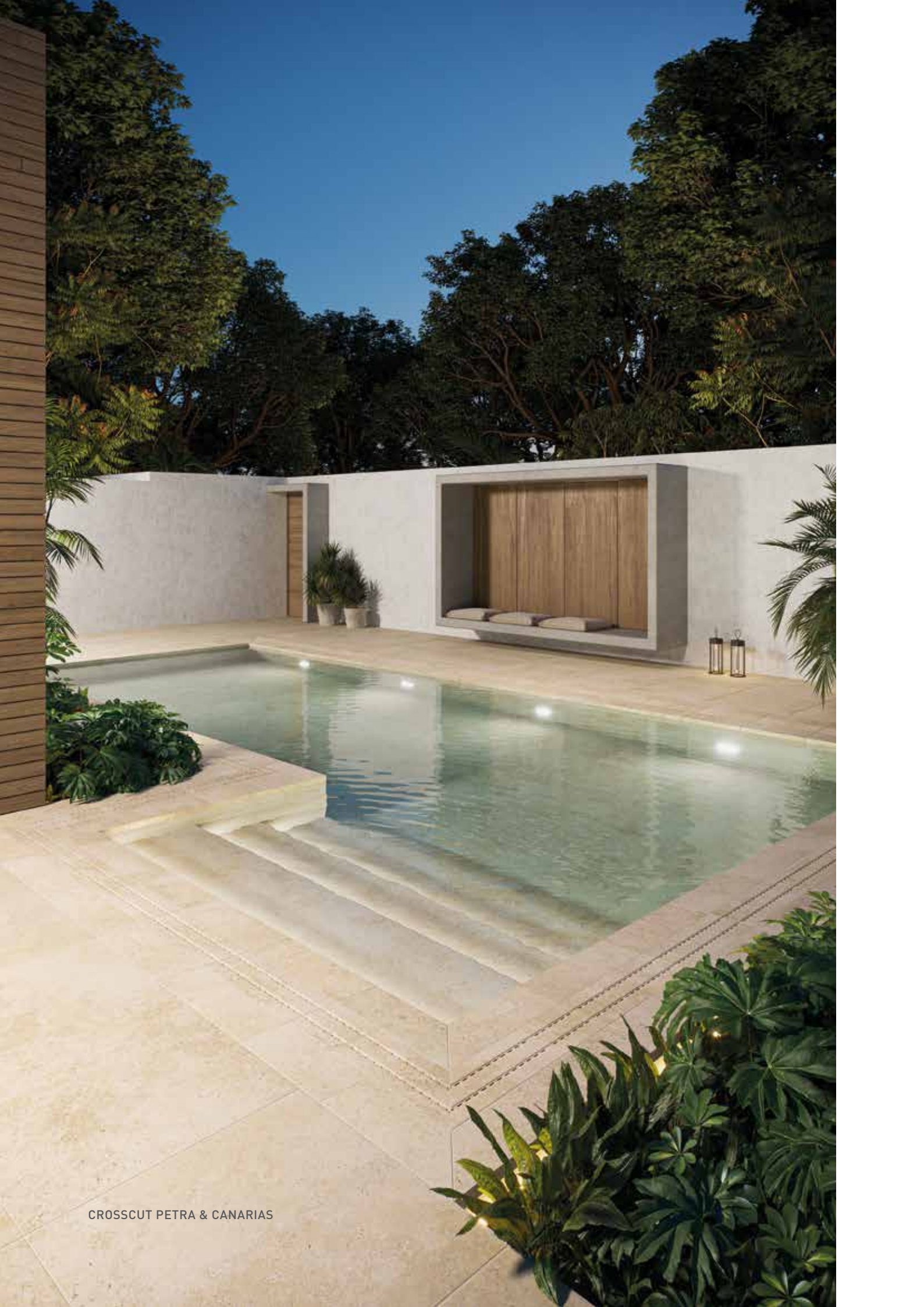

CROSSCUT PETRA & CANARIAS



STROMBOLI SILVER & CANARIAS

ARUBA

BASIC SYSTEM PIECES SISTEMA BÁSICO DE PIEZAS



ARUBA EDGE
BORDE ARUBA
BPAR 0000 25x50

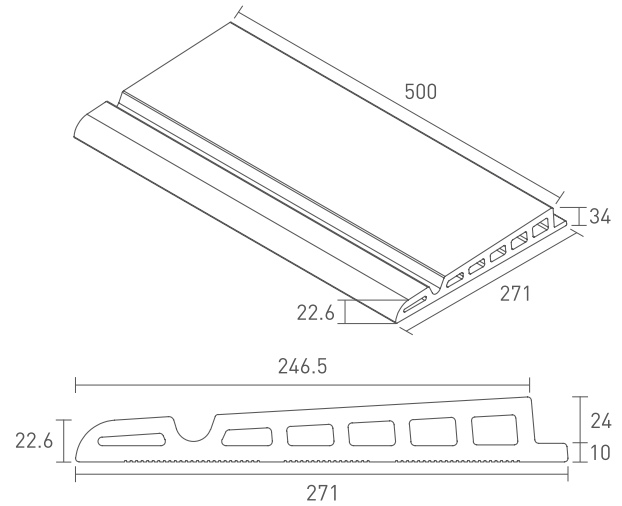

GRATE SUPPORT
SOPORTE PARA REJILLA
BSCA 0000 18x50

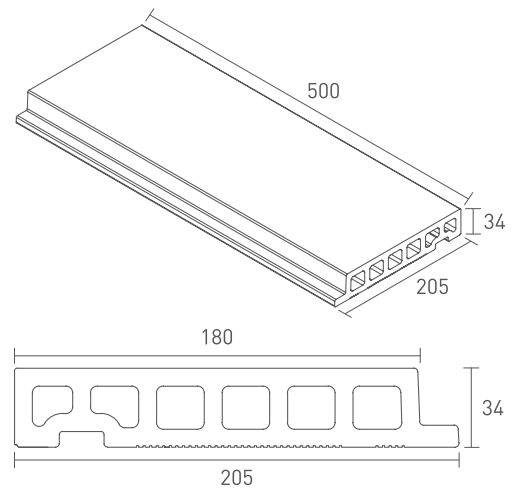

AVAILABLE COLOURS COLORES DISPONIBLES



Stromboli LIGHT



Stromboli CREAM



Stromboli SILVER



Crosscut PETRA



Crosscut CLOUD

CURVED SOLUTION
SOLUCIÓN CURVA

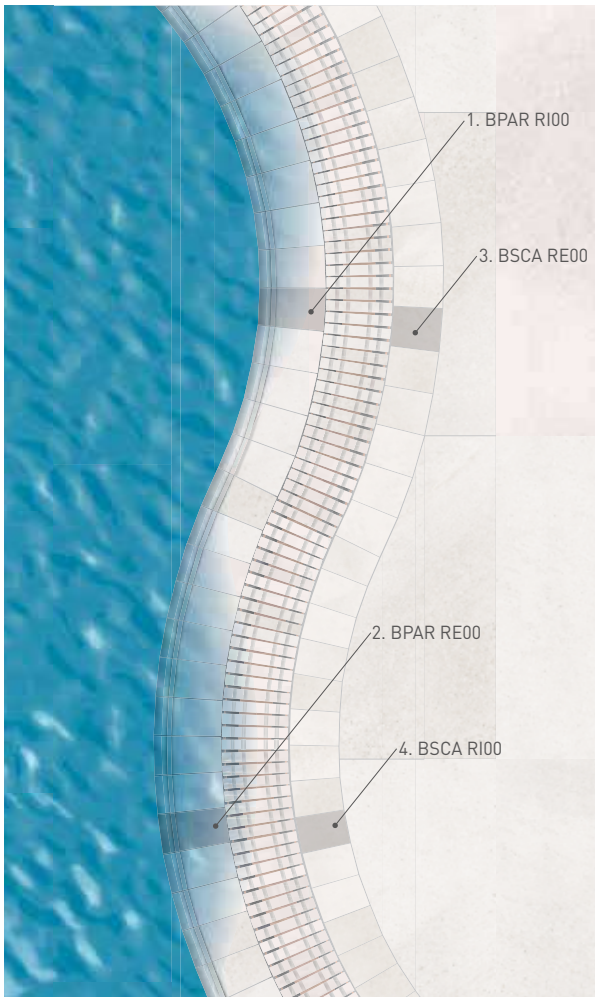

ARUBA CURVED EDGE

BORDE CURVO ARUBA

- ① BPAR RI00
- ② BPAR RE00

CANARIAS CURVED GRATE SUPPORT

SOPORTE CURVO CANARIAS PARA REJILLA

- ③ BSCA RE00
- ④ BSCA RI00

Both can be used with drain grates RJ25, RJ25 FLEX, RJ20 and RJ20 FLEX

Ambos son compatibles con las rejillas RJ25, RJ25 FLEX, RJ20 y RJ20 FLEX

CORNER SOLUTION
SOLUCIÓN ESQUINA

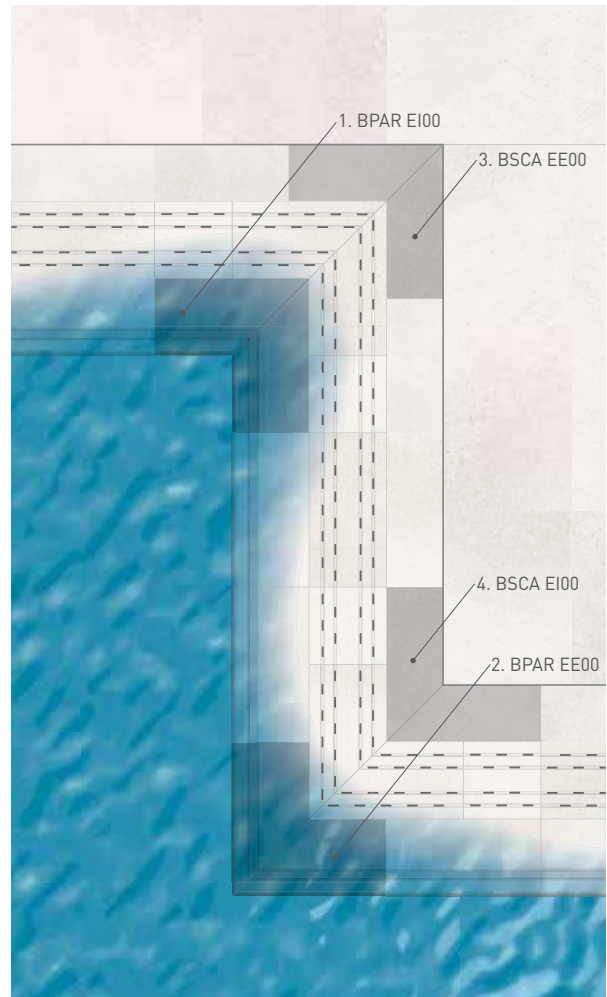

ARUBA EDGE CORNER PACK (2pcs)

PACK ESQUINA BORDE ARUBA (2pcs)

- ① BPAR EI00 20x_
- ② BPAR EE00 20x_

CANARIAS CORNER GRATE SUPPORT PACK (2pcs)

PACK SOPORTE ESQUINA CANARIAS PARA REJILLA (2pcs)

- ③ BSCA EE00 18x50
- ④ BSCA EI00 18x50

Both can be used with drain grates RJ25, RJ25 FLEX, RJ20 and RJ20 FLEX

Ambos son compatibles con las rejillas RJ25, RJ25 FLEX, RJ20 y RJ20 FLEX

TECHNICAL INFORMATION
INFORMACIÓN TÉCNICA

MONOBLOCK ONE PIECE, WITHOUT GLUED
UNA PIEZA, SIN PEGADO



UNE 41901
CLASE 3



EN ISO 10545-12
✓



DIN 51130
R11



DIN 51097
CLASE C



EN ISO 10545-13
GA / GLA / GHA



LONG LIFE
LARGA VIDA



EASY CLEAN
FÁCIL LIMPIEZA

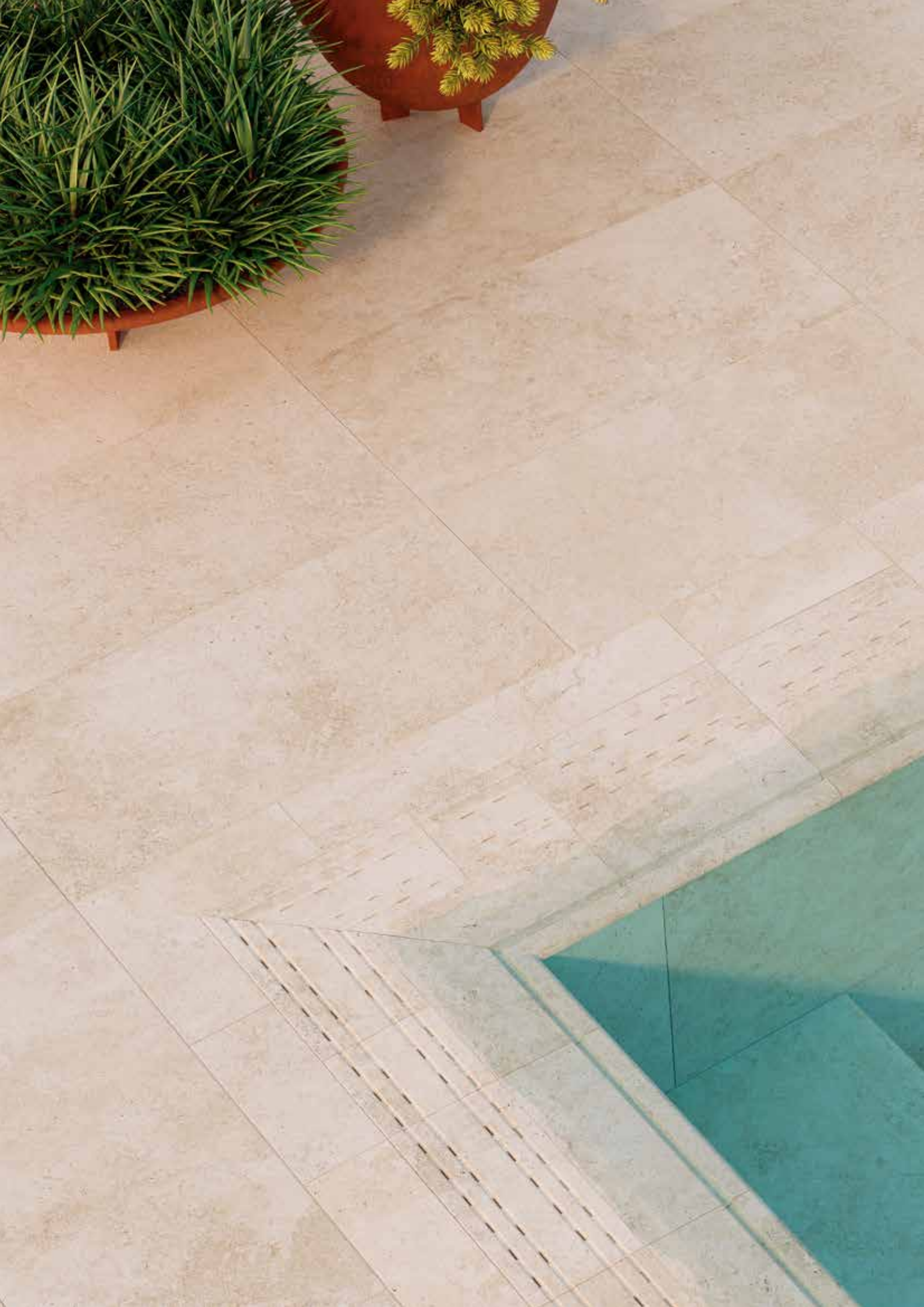

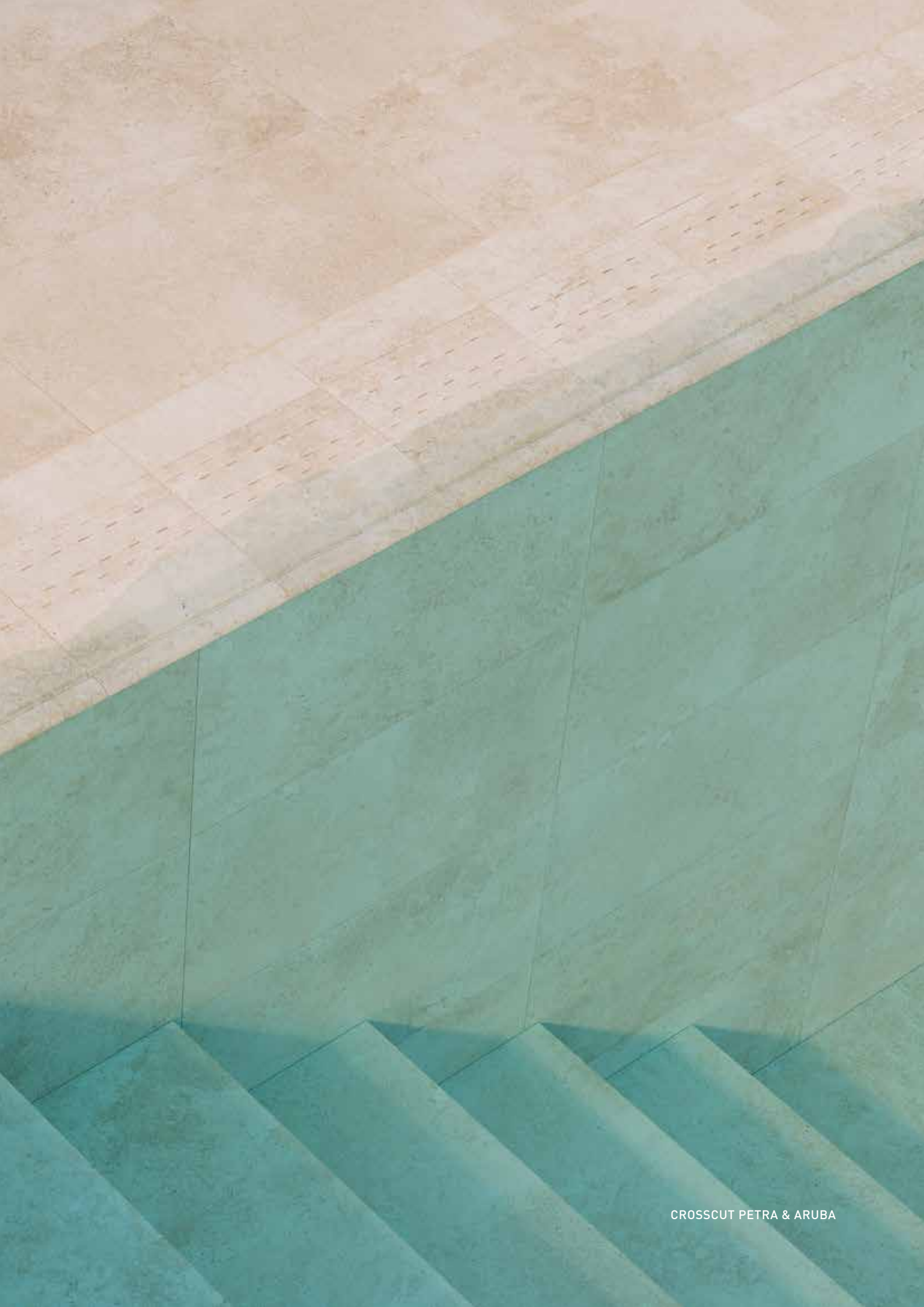

DRAIN GRATE RJ25

REJILLA DE DRENAJE RJ25

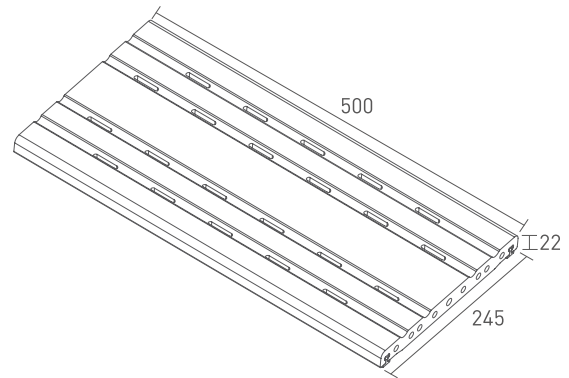

CERAMIC DRAIN GRATE
 REJILLA DE DRENAJE CERÁMICA
 RJ25 0000 25x50x2.2

out
 C3

Drain - Desagüe: >13m³/hora
 Grate rubber 9710 included
 Goma p/rejilla 9710 incluida

ANTISHOCK Worldwide Patent
 Patente Mundial



Component: Grate rubber
 Componente: Goma p/Rejilla
 Art. 9710

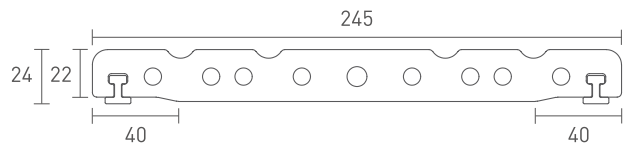

DRAIN GRATE CORNER
 ESQUINA REJILLA DRENAJE
 RJ25 E000 25x50x2.2

ANTISHOCK

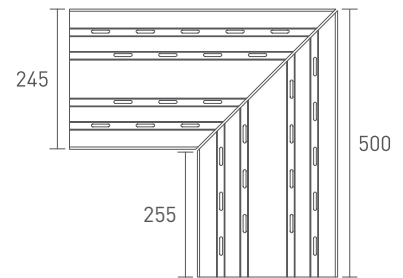

AVAILABLE COLOURS
 COLORES DISPONIBLES



Salem CLAR

Stromboli LIGHT	Woods ARCTIC	Cupira HUESO	Lao BONE	Cements SNOW	Calacatta FRESH
Stromboli CREAM	Woods NORDIC	Cupira MULTI	Lao SAND	Cements WARM	Crosscut PETRA
Stromboli SILVER	Woods OLIVO	Cupira MARENGO	Lao ASH	Cements SMOKE	Crosscut CLOUD

DRAIN GRATE RJ25 FLEX

REJILLA DE DRENAJE RJ25 FLEX

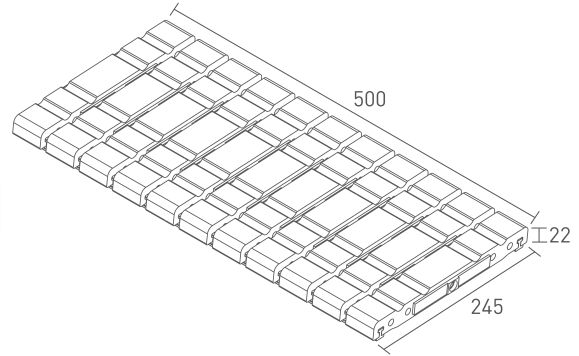

CERAMIC FLEX DRAIN GRATE
 REJILLA DE DRENAJE CERÁMICA FLEX
 RJ25 FLEX 25x50x2.2

out
C3

Drain - Desagüe: >30m³/hora
 Grate rubber 9710 included
 Goma p/rejilla 9710 incluida

 **ANTISHOCK**  Worldwide Patent
 Patente Mundial



Component: Grate rubber
 Componente: Goma p/Rejilla
 Art. 9710

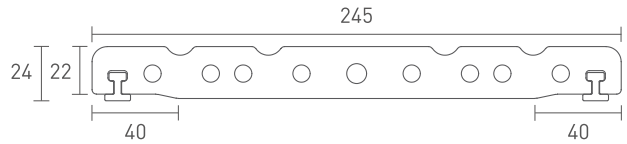

DRAIN GRATE CORNER
 ESQUINA REJILLA DRENAJE
 RJ25 E000 FLEX 25x29x2.2

 **ANTISHOCK**

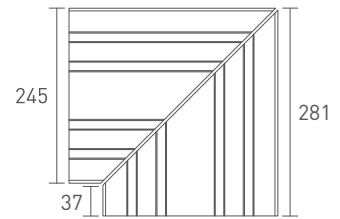
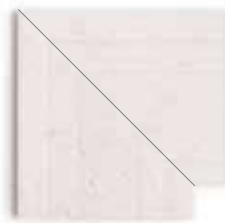

AVAILABLE COLOURS
 COLORES DISPONIBLES

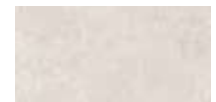

Salem CLAR

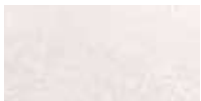

Stromboli LIGHT



Woods ARCTIC



Cupira HUESO



Lao BONE



Cements SNOW



Calacatta FRESH



Stromboli CREAM



Woods NORDIC



Cupira MULTI

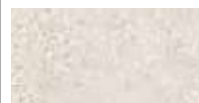

Lao SAND



Cements WARM



Crosscut PETRA



Stromboli SILVER



Woods OLIVO



Cupira MARENGO



Lao ASH



Cements SMOKE



Crosscut CLOUD

DRAIN GRATE RJ20

REJILLA DE DRENAJE RJ20

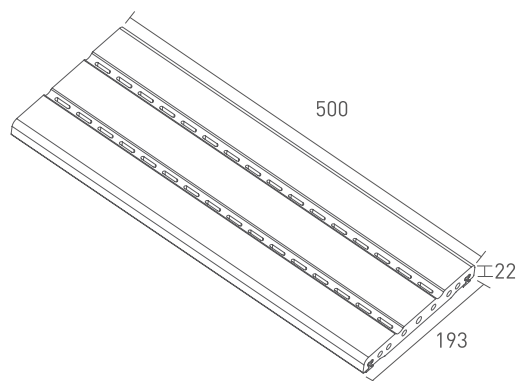

CERAMIC DRAIN GRATE
 REJILLA DE DRENAJE CERÁMICA
 RJ20 0000 20x50x2.2

out
 C3

Drain - Desagüe: >11m³/hora

Grate rubber 9710 included

Goma p/rejilla 9710 incluida

ANTISHOCK Worldwide Patent
 Patente Mundial



Component: Grate rubber
 Componente: Goma p/Rejilla
 Art. 9710

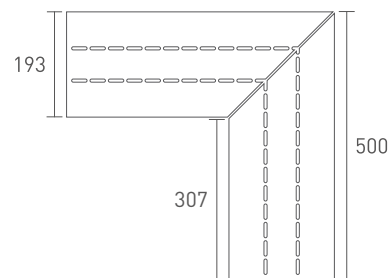
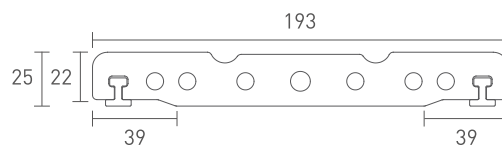

DRAIN GRATE CORNER
 ESQUINA REJILLA DRENAJE
 RJ20 E000 20x50x2.2

ANTISHOCK

AVAILABLE COLOURS

COLORES DISPONIBLES

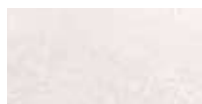

Stromboli LIGHT

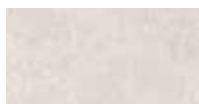

Salem CLAR



Stromboli CREAM



Crosscut PETRA



Stromboli SILVER



Crosscut CLOUD

DRAIN GRATE RJ20 FLEX

REJILLA DE DRENAJE RJ20 FLEX

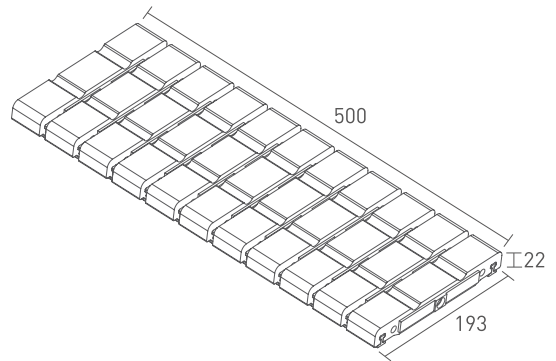

CERAMIC FLEX DRAIN GRATE
 REJILLA DE DRENAJE CERÁMICA FLEX
 RJ20 FLEX 20x50x2.2

out
C3

Drain - Desagüe: >30m³/hora
 Grate rubber 9710 included
 Goma p/rejilla 9710 incluida

 **ANTISHOCK**  Worldwide Patent
 Patente Mundial



Component: Grate rubber
 Componente: Goma p/Rejilla
 Art. 9710

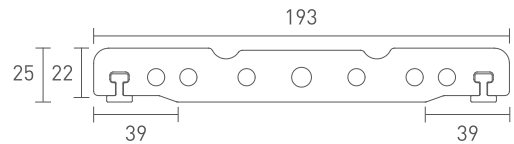

DRAIN GRATE CORNER
 ESQUINA REJILLA DRENAJE
 RJ20 E000 FLEX 20x29x2.2

 **ANTISHOCK**

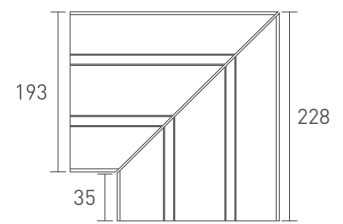
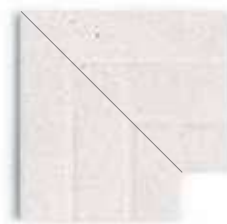
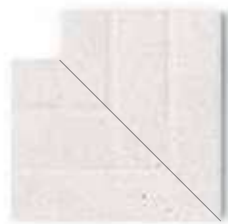

AVAILABLE COLOURS
 COLORES DISPONIBLES

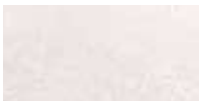

Stromboli LIGHT



Salem CLAR



Stromboli CREAM

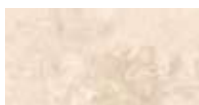

Crosscut PETRA



Stromboli SILVER



Crosscut CLOUD

TRIM

MEDIA CAÑA

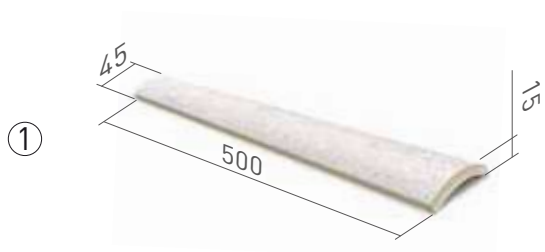

①

Outer trim
Media caña exterior
MDCA E000 4.5x50



②

Inner trim
Media caña interior
MDCA I000 5.5x50



③

Scotch outer corner
Escocia cantonera exterior
MDCA EE000 4.5x4.5

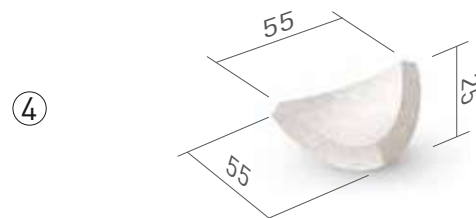

④

Scotch inner corner
Escocia cantonera interior
MDCA EI000 5.5x5.5

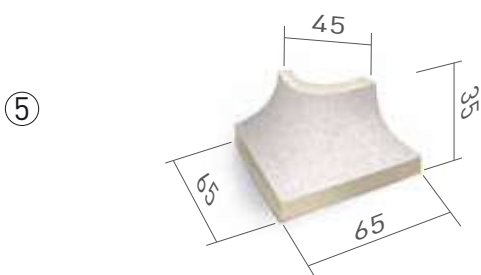

⑤

Outer angle corner
Esquina cantonera exterior
MDCA AE000 6.5x6.5

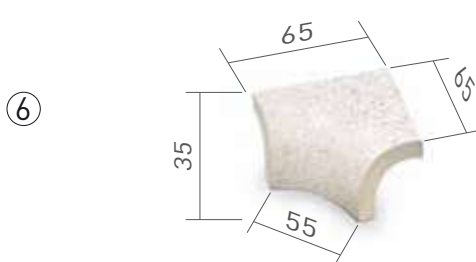

⑥

Inner angle corner
Esquina cantonera interior
MDCA AI000 6.5x6.5



⑦

External transition corner
Cantonera transición exterior
MDCA CE000 4.5x16

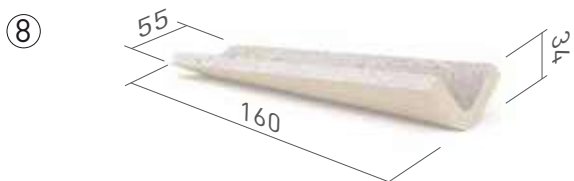

⑧

Inner transition corner
Cantonera transición interior
MDCA CI000 5.5x16

AVAILABLE COLOURS
COLORES DISPONIBLES

		Bali ZATU	Salem CLAR	Calacatta FRESH	Tropic TURQUETA
Stromboli LIGHT	Woods ARCTIC	Cupira HUESO	Lao BONE	Cements SNOW	Tropic AGUAMARINA
Stromboli CREAM	Woods NORDIC	Cupira MULTI	Lao SAND	Cements WARM	Crosscut PETRA
Stromboli SILVER	Woods OLIVO	Cupira MARENGO	Lao ASH	Cements SMOKE	Crosscut CLOUD





DIFFERENT EDGE CORNER SOLUTIONS

SOLUCIONES DIFERENTES PARA EL BORDE DE PISCINA

UNDERWATER RADIOUS *RADIO BAJO EL AGUA*



OUTSIDE EDGE RADIOUS *RADIO DEL BORDE EXTERIOR*

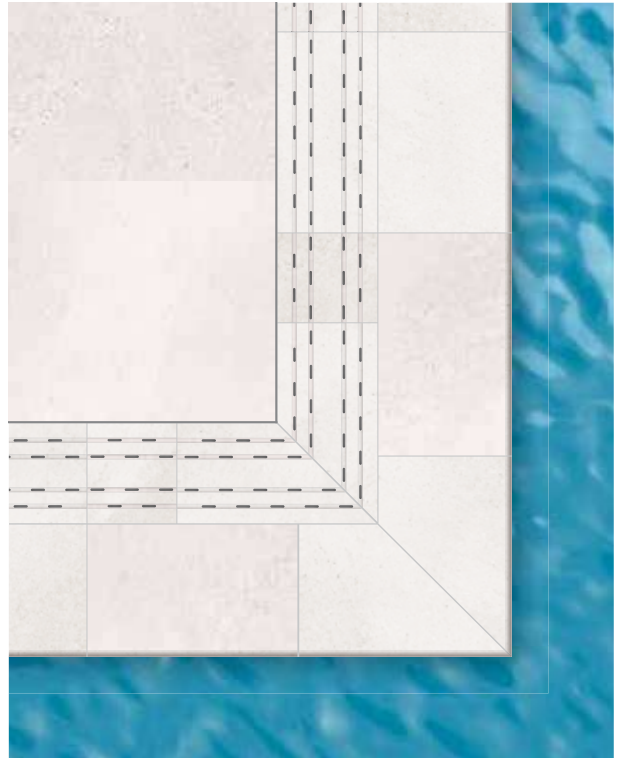

CURVED CORNERS *ESQUINAS CURVAS*

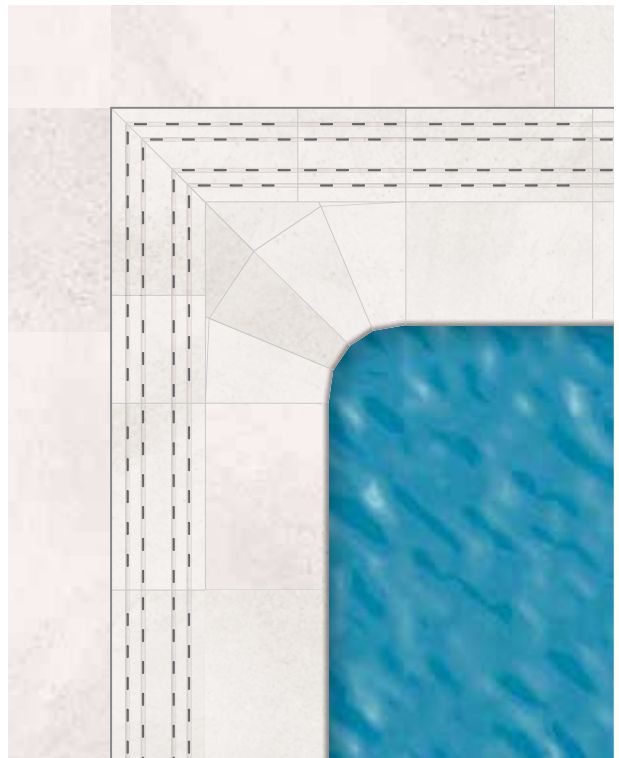
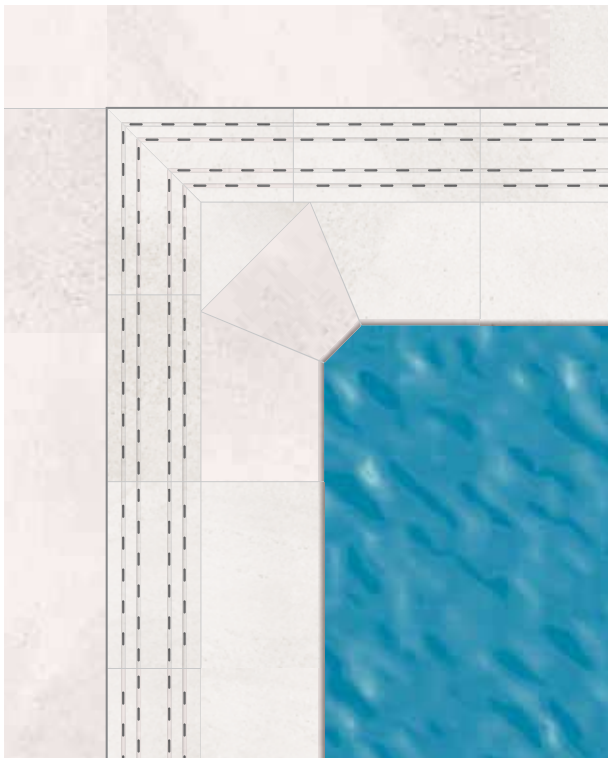



1,4m.

■ ■ ■ ■ PLACEMENT RECOMMENDATIONS
■ ■ ■ ■ RECOMENDACIONES DE MONTAJE

STEP FITTING INDICATIONS *MONTAJE DE PELDAÑOS*



SETTING-OUT ON SITE

We recommend to ensure that all the tiles fit properly at the stairs. At this point, it is important to consider all the necessary joints: expansion joints, perimeter joints, tile-to-tile joints and structural joints.

PLANIFICACIÓN

Nos aseguraremos de que las medidas de nuestro material encajan en la escalera. Debemos tener en cuenta todo tipo de juntas: estructurales, perimetrales, de dilatación, y de colocación.



SURFACE AND ADHESIVE METHOD **AND** **SUPERFICIE Y ENCOLADO**

The support surface should be well-formed, clean and dry. The adhesive is spread both, on the back side of the step tile and on the support. Then, the step tile should be positioned completely resting on the support.

La superficie debe estar bien conformada y seca. Eliminamos cualquier resto de suciedad. El adhesivo se extiende sobre el escalón de obra y sobre el peldaño. A continuación, colocamos el peldaño totalmente apoyado sobre la escalera.



IMPORTANT

We recommend to use appropriate bonding materials: the adhesive should be high-adherence and flexible and the grouts past should be waterproof and elastic. The level should be checked and adjusted.

IMPORTANTE

Para una correcta instalación de los peldaños es necesario utilizar junta elástica impermeable y cemento cola flexible. Comprobamos las piezas y ajustamos los niveles.

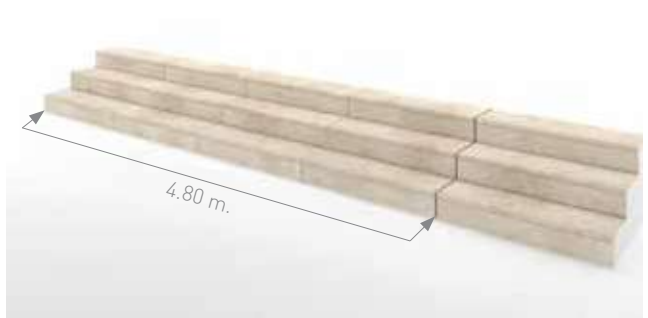

JOINTS

We recommend to use a tile-to-tile joint between 6 and 10mm. We recommend to install an expansion joint each 4m.

JUNTAS

Junta entre peldaños entre 6 y 10 mm. La junta de dilatación debe hacerse cada 4 metros.

SKIRTING BOARD APPLICATIONS *EL RODAPIÉ COMO SOLUCIÓN PARA ZANQUINES*

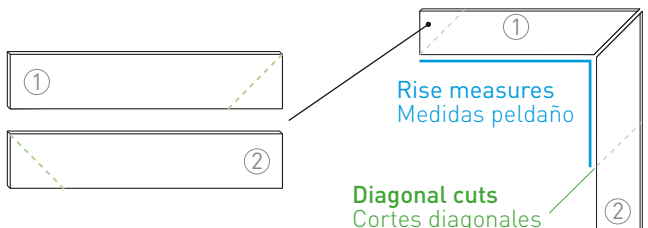



PROCEDURE FOR CERAMIC PIECES PLACEMENT IN POOLS

MANUAL DE COLOCACIÓN DE PIEZAS CERÁMICAS EN PISCINAS

Once we have prepared the pool shell, Cerámica Mayor suggests the following steps to achieve a correct execution in the placement of special pieces for pool edges.

Una vez se haya ejecutado el vaso de la piscina y preparado el soporte para recibir el material cerámico, Cerámica Mayor sugiere seguir los siguientes pasos para conseguir una correcta ejecución en la colocación de las piezas especiales de borde.

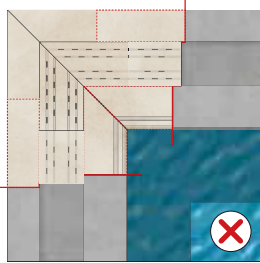

Incorrect alignment of pieces. Incorrect placement of pieces can cause breakage in pieces.

Una colocación incorrecta puede producir roturas en las piezas.

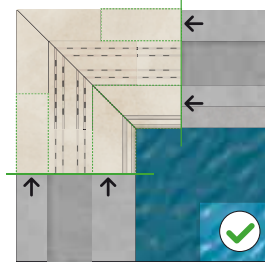

Correct alignment of pieces. These pieces must be cutted and adjusted on-site.

Alineación correcta de las piezas. Estas piezas se deberán de cortar y ajustar en obra.

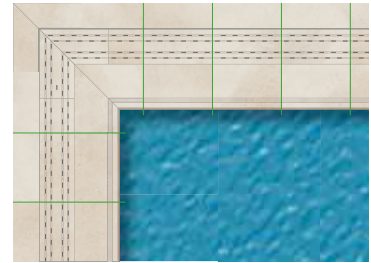

The placement of the pieces must start from the corners to the center of each side, keeping the linearity of the pieces.

La colocación de las piezas deberá de empezar de los extremos hacia el centro de cada uno de los lados, manteniendo la linealidad de las piezas.

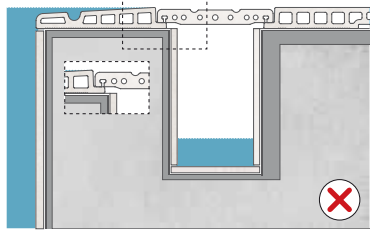

The grid should never be placed without joints due to the contractions and dilatations that pieces may suffer. Besides, the rubber provided by Cerámica Mayor must be always used to avoid vibrations.

Nunca se debe de colocar la rejilla sin junta debido a las contracciones y dilataciones que pueden sufrir las piezas. Además, es obligatorio la colocación de la goma proporcionada por Cerámica Mayor para evitar vibraciones.

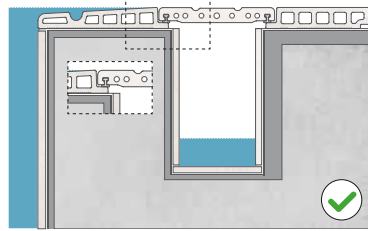

The grid must be placed over the edge and support flanges, and always with the rubber provided by Cerámica Mayor. Flexible, watertight and anti-acid tail mortar must be used for correct edge and support placement.

La rejilla deberá apoyar en las pestañas del borde y del soporte, colocando siempre la goma proporcionada por Cerámica Mayor. Se debe emplear mortero cola flexible, estanco y antiácido para la colocación del borde y soporte.

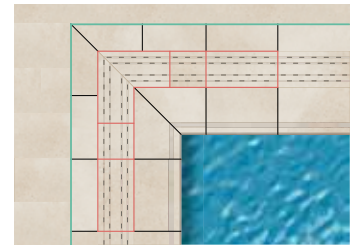

The expansion joints are very important to ensure correct ceramic pieces placement and to avoid possible breakages. Cerámica Mayor recommends:

- Open joint minimum 4 mm size
- Closed joint minimum 4 mm size
- Expansion joint

Las juntas son muy importantes en la colocación de las piezas para evitar posibles roturas. Cerámica Mayor recomienda:

- Junta abierta mínima 4mm
- Junta cerrada mínima 4mm
- Junta de dilatación

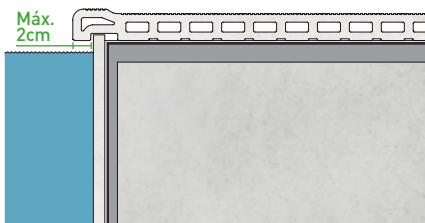

Cerámica Mayor suggests that the edge pieces never protrude more than 2 cm beyond the vertical wall of the pool shell.

Cerámica Mayor sugiere que la pieza de borde no sobresalga más de 2cm respecto el paramento vertical del vaso de la piscina. Un excesivo vuelo de la pieza podrá provocar una rotura en la misma.

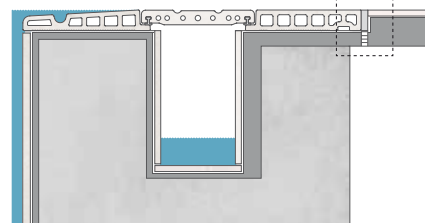

We also recommend placing an expansion joint between the edge pieces and terrace pieces to absorb possible contractions and dilatations. Moreover, every 25 sqm or 5 linear metres, expansion joints must be placed to avoid ceramic pieces breakages.

Recomendamos colocar una junta de dilatación entre el borde y la terraza para absorber las posibles contracciones y dilataciones. Además, cada 25m² o 5 ml colocar la junta de dilatación para evitar las roturas de piezas cerámicas.

¡AVISO IMPORTANTE! ANTES DE LA PUESTA EN OBRA.

- Verificar que la calidad que figura impresa en el embalaje se corresponde con la del material solicitado.
- Verificar la ausencia de defectos visibles (baldosas de 1ª calidad).
- Se requiere, al colocar, mezclar piezas de varias cajas.
- No se admitirán reclamaciones de problemas derivados del incumplimiento de estas premisas cuando el material ya esté colocado.

PARA CUALQUIER RECLAMACIÓN ES NECESARIA LA REFERENCIA DE LA CAJA



PROCEDIMIENTO PARA LA COLOCACIÓN

PREPARACIÓN DE LOS MATERIALES

- Cemento de agarre
- Nivel manual y elementos de medición necesarios
- Cuñas de nivelación
- Crucetas
- Pasta de rejunte
- Paleta
- Llana dentada
- Productos de limpieza

COMPROBAR LA CORRECTA NIVELACIÓN DEL SOPORTE

En terrazas y espacios exteriores es muy importante evacuar el agua correctamente para evitar que ésta quede estancada en la superficie. Cerámica Mayor recomienda lo siguiente:

- Imprescindible dar una pendiente mínima que esté comprendida entre el 1-3%.
- Se deberán colocar los suficientes canales sumideros para que no existan problemas de evacuación de aguas pluviales.
- El terreno tendrá que estar correctamente impermeabilizado y drenado para evitar el ascenso del agua por capilaridad.
- Se deberá de utilizar mortero de nivelación, también conocido como autonivelante con el fin de obtener un soporte sólido preparado para recibir las piezas de gres porcelánico.

LIMPIEZA DE LA SUPERFICIE

Se deberá de comprobar que la superficie esté exenta de restos de otros materiales tales como residuos de cemento, grasas, polvo, etc.

REPLANTEO DE LA SUPERFICIE

Con el fin de aprovechar al máximo el material cerámico se deberá de establecer una línea principal a partir de la cual se iniciará la colocación. En el replanteo se tendrán que tener en cuenta:

- Juntas perimetrales: Tendrá que ser > 5,00mm.
- Juntas estructurales: Deberán de coincidir con las juntas estructurales del edificio y serán como mínimo de 10mm y tendrán que ser de un material flexible.

■ Junta de partición: En áreas entre 20-30m² o 6-8ml se requerirá de una junta de partición de > 5,00mm.

■ Juntas de colocación: Para la colocación de Material Rectificado se requiere una junta de colocación >2,50 mm. Para la colocación de Material No Rectificado se requiere una junta de colocación >4,00mm, y además, se colocarán de forma trabada o en espiga (no se colocarán a más de 1/4 de su dimensión)

ELECCIÓN Y COLOCACIÓN DEL MATERIAL DE AGARRE

El material adhesivo a utilizar será cemento cola flexible C-2 TE S2 apropiado para la instalación de pavimento de gres porcelánico.

C: Adhesivo cementoso

2: Adhesivo mejorado

T: Adhesivo con deslizamiento reducido

E: Adhesivo con tiempo abierto ampliado

S2: Adhesivo altamente deformable

Una vez preparada la mezcla siguiendo las instrucciones del fabricante del producto, extenderemos con la ayuda de una llana dentada el cemento de agarre sobre la superficie previamente compacta y nivelada.

Se deberá extender también cemento de agarre en la parte posterior de la pieza con una llana dentada, generando de esta forma un doble encolado.

INSTALACIÓN DE LA PIEZA CERÁMICA

Con la ayuda de una maza de goma flexible se fijará la baldosa cerámica eliminando posibles burbujas de aire producidas por el material de agarre.

ELECCIÓN Y COLOCACIÓN DE MATERIAL DE REJUNTE

El material de rejunte a utilizar en las juntas perimetrales, juntas de colocación y juntas de partición sera rejuntado cementoso mejorado tipo CG2.

Una vez preparada la mezcla, siguiendo las instrucciones del fabricante del producto, extenderemos el material de rejuntado entre la separación de las piezas y se fijará con la ayuda de una llana de rejuntado.

RECOMENDACIÓN DE MONTAJE PARA BASES

37.5x75

20x120

30x120

60x120

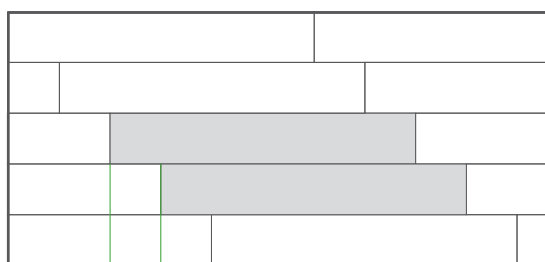

máx 20 cm

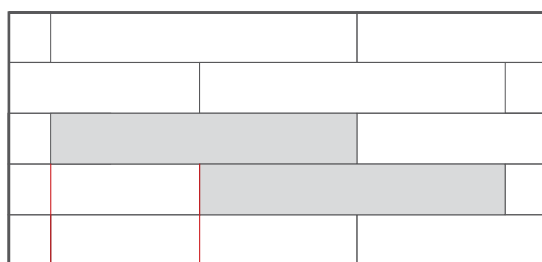

más de 20 cm





LIMPIEZA TRAS LA COLOCACIÓN

Es muy importante que, tras el rejuntado, se realice una buena limpieza para eliminar residuos y suciedad en general de la obra.

Hay que tener en cuenta que los productos de limpieza con agentes especiales no son necesarios e incluso pueden causar problemas a largo plazo ya que pueden depositar capas pegajosas de grasa, cera o plástico que tienen un efecto negativo en la apariencia, higiene, antideslizamiento y limpieza.

Los siguientes principios básicos se aplican al proceso de limpieza:

- Selección de un agente de limpieza adecuado.
- Esperar el tiempo necesario para que el agente de limpieza se filtre debajo de la suciedad y la afloje.
- Ayudar mecánicamente a este proceso mediante cepillos o métodos de limpieza apropiados. No utilizar en ningún caso almohadillas o cepillos con superficies abrasivas.
- Limpiar a fondo, enjuagar o aspirar la suciedad suelta.

Si con el transcurso del tiempo se observa una superficie de aspecto plástico con mayor dificultad para mantenerse, limpia de forma general, suele deberse a la formación de una capa superficial. Esa capa resulta difícil de eliminar con la fregona convencional, por lo que, para eliminarla y conseguir la superficie original, se debe emplear una disolución ligeramente ácida (añadir salfomán en una proporción 5% en agua) y ejercer una frotación más intensa (cepillo de púas de plástico duro). Aclarar con suficiente agua para eliminar la suciedad desincrustada.

No conviene utilizar agentes de limpieza que contengan ceras, ya que terminan formando una película sobre la baldosa que favorece la absorción y retención de sustancias extrañas, originando manchas fácilmente detectables y más difíciles de eliminar con la limpieza ordinaria.

Si se forman incrustaciones de jabón o de carbonatos del agua, conviene efectuar limpiezas periódicas con un producto detergente adecuado, dejándolo en reposo durante unos minutos antes de proceder a su eliminación.

El empleo de un mocho de microfibras y agua muy caliente favorecerá el secado de la superficie y minimizará la creación de una capa superficial sobre la baldosa (esta capa superficial facilita el posterior marcado de las huellas y una mayor propensión a captar la suciedad).

Para limpiezas extraordinarias, por ejemplo, las que son necesarias sobre superficies que han estado abandonadas de la limpieza mucho tiempo, se deben emplear detergentes en polvo o líquidos, frotando con una esponja o estropajo.

Especial atención a las juntas entre baldosas, que deberán restaurarse en caso de falta de integridad o estanqueidad, con sellantes adecuados. No es aconsejable la utilización de cuchillas o espátulas metálicas sobre la superficie vidriada ni el uso de productos concentrados sin haber probado antes en una parte no a la vista del material para confirmar la resistencia química del pavimento.

Accidentalmente, nos podemos encontrar con que el pavimento o revestimiento cerámico se manche por acción de alguna sustancia de diversa naturaleza. Existen procedimientos físicos y químicos para la eliminación de

manchas, debiéndose adoptar el más adecuado según el tipo de baldosa y naturaleza de la mancha.

A continuación, como ejemplo, se exponen algunos productos adecuados para el tratamiento de determinadas manchas según su naturaleza:

- Adhesivo cementoso: Detergente ácido.
- Restos de junta: Detergente ácido.
- Manchas orgánicas: Detergente alcalino.
- Pintura de rotulador: Disolvente (aguarrás, acetona, etanol).
- Restos de goma: Detergente alcalino, disolvente.
- Manchas de lápiz: Goma de borrar blanda.
- Grasa y mugre: Bicarbonato y agua.
- Tintas, mercromina: Solución diluida de hipoclorito sódico (lejía).
- Yodo o bromo: Detergente ácido, agua oxigenada o solución diluida de hipoclorito sódico (lejía), amoníaco.
- Sangre: Detergente ácido, agua oxigenada o solución diluida de hipoclorito sódico (lejía).
- Café, té, alimentos, fruta, zumo o cosméticos: Detergente normal disuelto en agua caliente con agua oxigenada o hipoclorito sódico (lejía).
- Restos de silicona: Cuchilla para limpiar vitrocerámica en superficies lisas y que no sean susceptibles de rayado. Para superficies con relieve o brillantes delicadas frente al rayado, se puede utilizar una mezcla de acetona y éter a partes iguales, aplicar sobre la silicona y esperar a que se desprenda.
- Alquitrán, betún, salpicaduras de pintura, residuos de juntas de expansión: Disolvente (aguarrás, acetona, etanol, gasolina).
- Resinas epoxídicas: Decapantes o agentes de limpieza especiales.

Cuando no se conozca la naturaleza de la mancha conviene realizar pruebas con diferentes detergentes, enjuagando la superficie con agua y secándola después de cada prueba. Puede resultar eficaz repetir el tratamiento varias veces o emplear agua caliente para favorecer la reacción. En cualquier caso, conviene consultar la ficha técnica del producto limpiador. Limpiar las superficies antideslizantes mejor con cepillo o limpiadores de alta presión o vapor.

NO SE DEBEN EMPLEAR EN LA LIMPIEZA PERIÓDICA SISTEMAS ROTATIVOS O MECÁNICOS CON ABRASIVOS DE DISTINTA NATURALEZA, YA QUE PUEDEN MODIFICAR EL BRILLO INICIAL, SEGÚN INTENSIDAD DEL TRATAMIENTO E INCLUSO EN CONDICIONES EXTREMAS, SEGÚN PRESIÓN Y ABRASIVO UTILIZADO, DETERIORAR LA SUPERFICIE Y REDUCIR LA RESISTENCIA AL DESLIZAMIENTO.

Los agentes de limpieza, dispositivos y procedimientos deben ser adecuados para el tipo de suciedad y el área de aplicación. Los restos de agentes de limpieza o desinfección pueden hacer que la superficie del piso sea resbaladiza y debe lavarse completamente. Los agentes de limpieza formadores de película también tienen un efecto negativo sobre la resistencia al deslizamiento. De igual manera, las aguas con mucha cal producen sedimentación sobre las baldosas y puede resultar en que la superficie quede resbaladiza, por lo que deben limitarse con mayor frecuencia de limpieza o con la instalación de descalcificaciones para el agua con cal.

IMPORTANT! BEFORE STARTING INSTALLATION, PLEASE NOTE THE FOLLOWING:

- Verify that the received material is what the customer ordered.
- Ensure that there are no important physical defects (in 1st quality material).
- It is recommended to mix pieces from several boxes when setting.
- Claims will not be accepted when the above conditions have not been fulfilled and the material has been installed.

THE BOX REFERENCE WILL BE NECESSARY FOR ANY CLAIM



PROCEDURE FOR PLACEMENT

PREPARATION OF MATERIALS

- Grip cement
- Spirit level and measuring elements
- Levelling wedges
- Auto-levelling spacers
- Grouting material
- Trowel
- Serrated trowel
- Cleaning products

CHECK THE CORRECT LEVELLING OF THE SUPPORT

On terraces and outdoor spaces it is very important to drain water correctly to prevent it from stagnating on the surface. Cerámica Mayor recommends the following:

- It is essential to provide a minimum slope of between 1-3%.
- Sufficient drainage channels should be installed to avoid rainwater drainage problems.
- The ground must be properly waterproofed and drained to prevent water rising by capillary action.
- Levelling mortar or also known as self-levelling mortar must be used to achieve a solid substrate ready to receive the stoneware tiles.

SURFACE CLEANLINESS

The surface must be checked to ensure that it is free of other materials such as cement residues, grease, dust, etc.

LAYING OUT THE SURFACE.

In order to avoid the wastage of material, a main line should be established from which the tile installation will begin. In the layout, the following must be taken into account:

- Perimeter joints: These should be $> 5.00\text{mm}$.
- Structural joints: These shall coincide with the structural joints of the building and shall be at least 10mm and be made of a flexible material.
- Partition joint: In areas between 20-30m² or 6-8ml a partition

joint of $> 5.00\text{mm}$ will be required.

- Tile joints: For the installation of Rectified Material, a tile joint $>2.50\text{mm}$ is required. For the installation of Not Rectified Material is necessary a tile joint $>4.00\text{mm}$, and in addition, they shall be installed in a random laying or herringbone manner (they shall not be installed at more than $1/4$ of their dimension).

CHOICE AND INSTALLATION OF THE BONDING MATERIAL

The adhesive material to be used shall be C-2 TE S2 flexible cementitious adhesive suitable for the installation of porcelain stoneware flooring.

C: Cementitious adhesive

2: Improved adhesive

T: Reduced slip adhesive

E: Adhesive with extended open time

S2: Highly deformable adhesive

Once the mixture has been prepared according to the product manufacturer's instructions, spread the bonding cement on the previously compacted and levelled surface with the help of a notched trowel.

The bonding cement should also be spread on the back of the workpiece with a notched trowel, thus creating a double bond.

INSTALLATION OF THE CERAMIC TILE

With the help of a flexible rubber mallet, the ceramic tile will be fixed, eliminating possible air bubbles produced by the bonding material.

CHOICE AND INSTALLATION OF GROUT.

The grout material to be used in the perimeter joints, tile joints and partition joints shall be CG2 type improved cementitious grout.

Once the mixture has been prepared, following the product manufacturer's instructions, spread the grout between the separation of the pieces and fix it with the help of a grout trowel.

TILES MOUNTING RECOMMENDATION

37.5x75

20x120

30x120

60x120

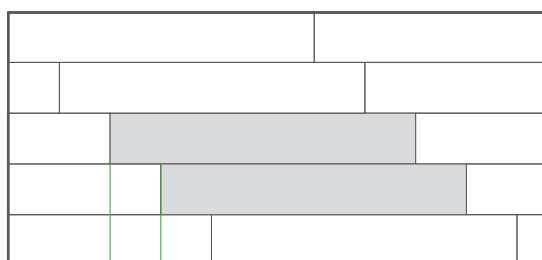

max 20 cm

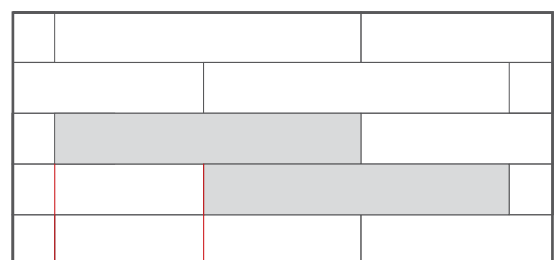

more than 20 cm





CLEANING AFTER INSTALLATION

To finish this process, it is very important that after grouting, a good cleaning is carried out to remove residues and dirt in general from the building site. It is important to note in this process that cleaning agents with special care products are not necessary and can even cause problems in the long run as they can deposit sticky layers of grease, wax or plastic that have a negative effect on appearance, hygiene, slip resistance and cleanliness. The following basic rules should be applied to the cleaning process:

- Select the best suitable cleaning product.
- Give it the enough time to penetrate and dissolve the dirt.
- It is recommended to use mechanical methods to help in the cleaning process like brush or mop. Avoid abrasive brushes that could damage the surface.
- Last part is to wash away with plenty clean water all the dirt and remains of cleaning product.

If, over time, a plastic-looking surface becomes more difficult to keep clean, this is usually due to the formation of a surface layer. This layer is difficult to remove with a conventional mop, so to remove it and achieve the original surface, use a slightly acidic solution (add 5% acid-based cleaning in water) and scrub more intensely (with a hard plastic bristle brush).

Subsequently rinse with sufficient water to remove the dirt. It is not recommended to use cleaning agents that contain waxes in their composition, as they end up forming a film on the ceramic tile that favours the absorption and retention of foreign substances, causing stains that are easily detectable and more difficult to remove with ordinary cleaning operations. If soap or carbonate deposits are formed in the water, it is convenient to clean periodically with a suitable detergent product, leaving it to stand for a few minutes before removing it.

The use of a micro-fibre mop and very hot water will favour the drying of the surface and minimise the creation of a surface layer on the tile (this surface layer facilitates the subsequent marking of footprints and a greater probability of dirt pick-up).

For extraordinary cleaning, for example, on surfaces that have been neglected for a long time, powder or liquid detergents should be used, applied by rubbing with a sponge or scouring sponge.

Special attention should be paid to the joints between tiles, which should be restored in case of lack of integrity or watertightness, with suitable sealants. It is not advisable to use metal blades or trowels on the glazed surface. It is also not recommended to use concentrated products without first testing this product on an unexposed part to confirm the chemical resistance of the tiles.

Accidentally, we may find that the ceramic floor or wall tile is stained by the action of one or more substances of different kinds. There are physical and chemical procedures for removing stains and incrustations, and the most suitable one

should be adopted according to the type of tile and the nature of the stain.

The following are some examples of products that can be used to treat certain stains depending on their nature:

- Cementitious adhesive: Acid detergent
- Joint residues: Acid detergent
- Organic stains: alkaline detergent
- Marker pen paint: Solvent (turpentine, acetone, ethanol)
- Gum residues: Alkaline detergent, solvent
- Pencil smudges: Soft eraser
- Grease and grime: Baking soda and water
- Inks, mercurochrome: diluted sodium hypochlorite solution (bleach)
- Iodine or bromine: Acid detergent, hydrogen peroxide or dilute sodium hypochlorite solution (bleach), ammoniac.
- Blood: Acid detergent, hydrogen peroxide or dilute sodium hypochlorite solution (bleach).
- Coffee, tea, food, fruit, juice or cosmetics: Normal detergent dissolved in hot water with hydrogen peroxide or sodium hypochlorite (bleach).
- Silicone residues: Blade for cleaning glass ceramic on smooth surfaces that are not susceptible to scratching.
- For embossed or shiny surfaces that are sensitive to scratching, a mixture of equal parts of acetone and ether can be used, applied to the silicone and allowed to come off.
- Tar, bitumen, paint splashes, expansion joint residues: Solvent (turpentine, acetone, ethanol, petrol).
- Epoxy resins: Paint strippers or special cleaning agents.

When the nature of the stain is not known, it is better to test with different detergents, washing the surface with water and drying it after each test. In other cases, it may be effective to repeat the treatment several times or to use hot water to encourage the reaction. In any case, it is important to consult the technical data sheet of the cleaning product. Non-slip surfaces are best cleaned with a brush or with high-pressure or steam cleaners.

WE SHOULD NOT USE CLEANING MACHINES (ABRASIVE MECHANICAL BRUSHES) PERIODICALLY FOR THE CLEANING PROCESS AS THIS MAY AFFECT TO INITIAL GLOSS OF THE SURFACE OR COULD EVEN DAMAGE THE TILE PROPERTIES LIKE THE SLIP RESISTANCE .

The cleaning agent, cleaning device and cleaning process must be suitable for the type of contamination and the area of use. Residues of cleaning or disinfecting agents can make the floor surface slippery and should be thoroughly washed off. Cleaning agents that create a coating also have a negative effect on slip resistance. In the same way, water with significant amounts of limescale causes sedimentation on the tiles, which can result in a slippery floor surface, so that incrustations must be limited, possibly by more frequent cleaning or by installing descalers for the cleaning water.



PIECES DIMENSIONS

DIMENSIONES DE LAS PIEZAS

14.7x14.7*
OUT Base



0.8 cm L1

14.7x14.7*
IN Base



0.83 cm L1

Skirting board *Rodapié*

9x60

0.9 cm L1

37.5x75^R
OUT Base



0.9 cm L1

60x60^R
OUT Base



60x60^R
IN Base



0.9 cm L1

14.5x120^R
Riser Tabica

0.9 cm L1

20x120^R
OUT Base



20x120^R
IN Base



0.9 cm L1

75x75^R
OUT Base



75x75^R
IN Base



0.9 cm L1

30x120^R
OUT Base



30x120^R
IN Base



0.9 cm L1

60x120^R 2CM
OUT Base



2 cm L1

60x120^R
OUT Base

60x120^R
IN Base



0.9 cm L1

90x90^R
OUT Base



90x90^R
IN Base



0.9 cm L1

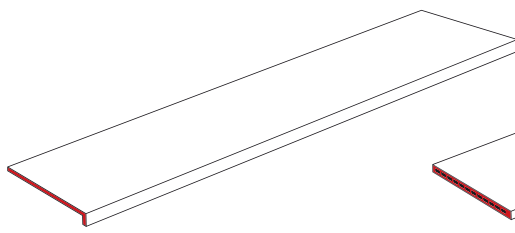

Recto Step 33x120

Peldaño Recto 33x120

▲ 47.2x12.9 in. | 33x120 cm

⊕ 0.43 in. | 1.1 cm

⊖ 1.33 in. | 3.4 cm

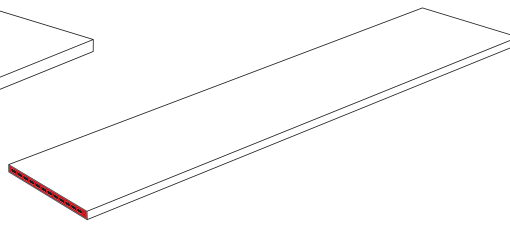

Full Step 33x120

Peldaño Completo 33x120

▲ 47.2x12.9 in. | 33x120 cm

⊕ 0.94 in. | 2.4 cm

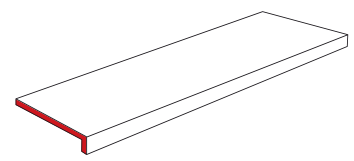

Window sill 18x50

Vierteaguas 18x50

▲ 7.08x19.68 in. | 18x50 cm

⊕ 0.43 in. | 1.1 cm

⊖ 1.26 in. | 3.2 cm

MONOBLOCK















ONE PIECE,
NOT GLUED

UNA PIEZA,
SIN PEGADO



TECHNICAL INFORMATION OF THE BASES

INFORMACIÓN TÉCNICA DE LAS BASES

Resistance to surface abrasion Resistencia a la abrasión		EN ISO 10545-7	PEI IV-V	Stain resistance Resistencia a las manchas		EN ISO 10545-14	5
Frost resistance Resistencia a la helada		EN ISO 10545-12	✓	Chemical resistance Resistencia química		EN ISO 10545-13	GA/GLA/GHA
Thermal shock resistance Resistencia al choque térmico		EN ISO 10545-9	✓	Scratch resistance · OUT Resistencia al rayado · OUT		UNE 67101	9
Modulus of rupture Resistencia a la flexión		EN ISO 10545-4	>23N/mm ²	Water absorption Absorción de agua		EN ISO 10545-3	<0,5%
Antislip · OUT Antideslizante · OUT		DESLIZAMIENTO	UNE 41901 Clase 3	Fire resistance Resistencia al fuego		CLASE A1fl Sin necesidad de ensayo (Decisión 96/603/ECC Modificada)	✓
Antislip · OUT Antideslizante · OUT		Antislip Antideslizante	DIN 51130 R11	Impact resistance Resistencia al impacto		EN ISO 10545-5	✓
Antislip · OUT Antideslizante · OUT		Antislip Antideslizante	DIN 51097 Clase C	Dimensional tolerance Tolerancia dimensional		Dimensional tolerance Tolerancia dimensional	✓

PACKING LIST | 2023

FEC-HA: 01/01/2023

PAVIMENTO

	pladetas	piezas/caja	m ² /caja	cajas/pallet	kg/caja	kg/pallet bruto	m ² /pallet	piezas/pallet	laminado pallet	ETIPIA	PALMAYITA	LAO	SALIM	TROPIC	AMAZONIA	CUPIRA	CROSSCUT	CEMENTS	WOODS	STONED	SEA ROCK	BALI	
	23,6" x 23,6"	4	1,4400	32	27,00	950	46,08	128	120x80x74			♦				♦							
	23,6" x 23,6"	4	1,4400	32	27,00	950	46,08	128	120x80x74			♦				♦							
	14,8" x 29,5"	4	1,1250	55	23,50	1.320	61,87	220	120x80x89							♦							
	29,5" x 29,5"	2	1,1250	48	23,50	1.140	54,00	96	120x80x90							♦							
	29,5" x 29,5"	2	1,1250	48	23,50	1.160	54,00	96	120x80x90							♦							
	7,8" x 47,2"	7	1,6800	44	23,50	1.058	73,92	308	120x80x83							♦							
	7,8" x 47,2"	7	1,6800	44	23,50	1.058	73,92	308	120x80x83							♦							
	11,6" x 47,2"	4	1,4400	36	32,00	1.150	51,84	144	120x80x74							♦							
	11,6" x 47,2"	4	1,4400	36	32,00	1.150	51,84	144	120x80x74							♦							
	23,6" x 47,2"	2	1,4400	36	30,00	1.103	51,84	72	120x84x74			♦				♦							
	23,6" x 47,2"	2	1,4400	36	30,00	1.103	51,84	72	120x84x74			♦				♦							
	35,4" x 35,4"	2	1,6200	30	32,50	1.035	48,60	60	106x95x74							♦							
	35,4" x 35,4"	2	1,6200	30	32,50	1.035	48,60	60	106x95x74							♦							
	23,6" x 47,2"	1	0,7200	27	34,37	928	19,44	27	120x84x74							♦							
	58" x 58"	42	0,9076	80	16,20	1.296	72,60	3.360	120x80x89				♦										
	58" x 58"	44	0,9508	80	16,97	1.357	74,06	3.520	120x80x89				♦										
	12,9" x 47,2"	2	-	32	23,18	742	-	64	125x110x81,5							♦							
	12,9" x 47,2"	1	-	32	11,59	371	-	32	125x110x81,5							♦							
	12,9" x 47,2"	1	-	32	12,00	386	-	32	125x110x81,5							♦							
	12,9" x 47,2"	2	-	32	23,18	742	-	64	125x110x81,5							♦							
	12,9" x 47,2"	1	-	32	11,59	371	-	32	125x110x81,5							♦							
	12,9" x 47,2"	1	-	32	12,00	386	-	32	125x110x81,5							♦							
	12,9" x 47,2"	2	-	40	32,40	1.296	-	80	125x110x81,5							♦							
	3,5" x 17,7"	8 set	-	99	19,20	1.901	-	792 set	-							♦							
	3,5" x 17,7"	8 set	-	99	19,21	1.902	-	792 set	-							♦							
	3,5" x 17,7"	10	-	144	11,73	1.689	-	1.440	110x95x110							♦							
	5,3" x 47,2"	6	-	75	22,20	1.665	-	450	125x110x90							♦							
	7,1" x 19,6"	6	-	72	14,04	1.011	-	432	110x95x115							♦							
	-	-	-	-	-	-	-	-	-							♦							
	19,6" x 47,2"	1	-	42	25,50	1.071	-	42	125x110x84			♦				♦							
	-	1 set	-	-	-	-	-	-	-			♦				♦							
	-	/radio	-	-	-	-	-	-	-			♦				♦							
	12,9" x 19,6"	2	-	60	13,60	816	-	120	110x85x80			♦				♦							
	-	1 set	-	-	-	-	-	-	-			♦				♦							
	-	/radio	-	-	-	-	-	-	-			♦				♦							

SAMOA

CRETA

PISCINA

		17,7"x 27,5"	2	-	22	30,10	663	-	44	110x75x90														
BORDES DE PISCINA	MIKONOS 	BORDE MIKONOS Ref. BPMI 0000 45x70 PACK ESQUINA BORDE MIKONOS Ref. BPMI E000 45x70 / BPMI E100 45x70 BORDE MIKONOS CURVO Ref. BPMI RE00 45x_ / BPMI R100 45x_	-	1 set	-	-	-	-	-	-	-													
	MAUI 	BORDE MAUI - Ref. BPMA 0000 33x50 BORDE MAUI PACK ESQUINA Ref. BPMA E000 33x50 / BPMA E100 33x50 BORDE MAUI Ref. BPMA RE00 33x_ / BPMA R100 33x_	12,9" x 19,6"	1 set	-	-	798	-	120	110x85x80														
	BORA 	BORDE BORA - Ref. BPBO 0000 20x50 BORDE BORA PACK ESQUINA Ref. BPBO E000 20x50 / BPBO E100 20x50 BORDE CURVO BORA Ref. BPBO RE00 20x_ / BPBO R100 20x_	7,9" x 19,6"	1 set	-	104	9,20	957	-	208	110x95x90													
	ARUBA 	BORDE ARUBA - Ref. BPAR 0000 25x50 BORDE ARUBA PACK ESQUINA Ref. BPAR E000 25x50 / BPAR E100 25x50 BORDE CURVO ARUBA - Ref. BPAR RE00 25x_ / BPAR R100 25x_	9,8" x 19,6"	1 set	-	66	11,11	748,26	-	132	110x95x90													
	CANARIAS 	BORDE SOPORTE CANARIAS - Ref. BSCA 0000 18x50 PACK ESQUINA BORDE SOPORTE CANARIAS Ref. BSCA E000 18x50 / BSCA E100 18x50 BORDE SOPORTE CANARIAS CURVO Ref. BSCA RE00 18x_ / BSCA R100 18x_	7,1" x 19,6"	1 set	-	88	9,32	835,16	-	176	110x95x90													
	REJILLAS DE DRENAJE	RJ25 FLEX RJ25 	REJILLA CERÁMICA RJ25 - Ref. RJ25 0000 25x50 REJILLA CERÁMICA RJ25 PACK ESQUINA Ref. RJ25 E000 25x_	9,8" x 19,6"	1 set	-	96	9,60	922	-	192	110x105x90												
		RJ20 FLEX RJ20 	REJILLA CERÁMICA RJ25 CURVA Ref. RJ25 RE00 25x_ / RJ25 R100 25x_	-	/radio	-	-	-	-	-	-	-												
		RJ20 FLEX RJ20 	REJILLA CERÁMICA RJ25 FLEX - Ref. RJ25 FLEX 25x50 REJILLA CERÁMICA RJ25 FLEX PACK ESQUINA Ref. RJ25 E000 FLEX 25x_	9,8" x 19,6"	2	-	96	9,60	922	-	192	110x105x90												
		RJ20 FLEX RJ20 	REJILLA CERÁMICA RJ20 - Ref. RJ20 0000 20x50 REJILLA CERÁMICA RJ20 PACK ESQUINA Ref. RJ20 E000 20x_	7,9" x 19,6"	1 set	-	128	7,80	998	-	256	110x95x90												
		RJ20 FLEX RJ20 	REJILLA CERÁMICA RJ20 CURVA Ref. RJ20 RE00 20x_ / RJ20 R100 20x_	-	/radio	-	-	-	-	-	-	-												
SOLUCIONES	MEDIA CAÑA 	REJILLA CERÁMICA RJ20 FLEX - Ref. RJ20 FLEX 20x50 REJILLA CERÁMICA RJ20 FLEX PACK ESQUINA Ref. RJ20 E000 FLEX 20x_	7,9" x 19,6"	2	-	128	7,80	998	-	256	110x95x90													
	MEDIA CAÑA 	MEDIA CAÑA - Ref. MDCA E000 4,5x50 / MDCA I000 5,5x50 MEDIA C. ESQUINA - Ref. MDCA E000 4,5x4,5 / MDCA E100 5,5x5,5 MEDIA C. ÁNGULO - Ref. MDCA A000 6,5x6,5 / MDCA A100 6,5x6,5 MEDIA C. CANTO - Ref. MDCA C000 4,5x16 / MDCA C100 5,5x16	1,8x19,77/21" x19,77" 1,8" x1,87/21" x21" 2,5" x2,5" / 2,5" x2,5" 1,8" x6,3/2,1" x6,3"	-	-	-	-	-	-	-	-													
	GOMA PARA REJILLA 	GOMA PARA REJILLA - Ref. 7966 COSTE EXTRA CURVA ESPECIAL - Ref. 6624	-	-	-	-	-	-	-	-	-													

(*) Bases sin rectificar (♦) Cements: Snow (♦) Cupira: Hueso (♦) Salem: Clar
 (R) Bases rectificadas (■) Cupira: Hueso + Marengo (●) Stromboli: Light
 Los pesos pueden sufrir variaciones (▼) Cupira: Multi + Marengo (✗) Stromboli: Light + Cream



CERÁMICA MAYOR S.A.
 C.I.F. A-03108669
 Parida Planet, s/n
 03510 Callosa d'En Sarrià
 (Alicante-España)
 +34 945 881 175
 info@ceramicamayor.com



PACKING LIST | 2023

DATE: 01/01/2023

FLOOR TILES

	Inches	pieces/box	SQM/box	box/pallet	kg/box	kg/pallet/gross	SQM/pallet	pieces/pallet	pallet size	ETRYA	DALACATTA	LAO	SALAM	TROIC	AMAZONIA	CUPIRA	CROSSOUT	CEMENTS	WOODS	STONOLI	SEA ROCK	BALI	
BASE 60x60° cm - OUT	23,6" x 23,6"	4	1,4400	32	27,00	950	46,08	128	120x80x74														
BASE 60x60° cm - IN	23,6" x 23,6"	4	1,4400	32	27,00	950	46,08	128	120x80x74														
BASE 37,5x75° cm - OUT	14,8" x 29,5"	4	1,1250	55	23,50	1.320	61,87	220	120x80x89														
BASE 75x75° cm - OUT	29,5" x 29,5"	2	1,1250	48	23,50	1.140	54,00	96	120x80x90														
BASE 75x75° cm - IN	29,5" x 29,5"	2	1,1250	48	23,50	1.160	54,00	96	120x80x90														
BASE 20x120° cm - IN	7,8" x 47,2"	7	1,6800	44	23,50	1.058	73,92	308	120x80x83														
BASE 20x120° cm - OUT	7,8" x 47,2"	7	1,6800	44	23,50	1.058	73,92	308	120x80x83														
BASE 30x120° cm - OUT	11,6" x 47,2"	4	1,4400	36	32,00	1.150	51,84	144	120x80x74														
BASE 30x120° cm - IN	11,6" x 47,2"	4	1,4400	36	32,00	1.150	51,84	144	120x80x74														
BASE 60x120° cm - OUT	23,6" x 47,2"	2	1,4400	36	30,00	1.103	51,84	72	120x84x74														
BASE 60x120° cm - IN	23,6" x 47,2"	2	1,4400	36	30,00	1.103	51,84	72	120x84x74														
BASE 90x90° cm - OUT	35,4" x 35,4"	2	1,6200	30	32,50	1.035	48,60	60	106x95x74														
BASE 90x90° cm - IN	35,4" x 35,4"	2	1,6200	30	32,50	1.035	48,60	60	106x95x74														
BASE 60x120° cm de 2 cm - OUT	23,6" x 47,2"	1	0,7200	27	34,37	928	19,44	27	120x84x74														
BASE 60x120° cm - IN	58" x 58"	42	0,9076	80	16,20	1.296	72,60	3.360	120x80x89														
BASE 14,7x14,7* cm - OUT	5,8" x 5,8"	44	0,9508	80	16,97	1.357	74,06	3.520	120x80x89														
RECTO STEP 120x33 cm - OUT	12,9" x 47,2"	2	-	32	23,18	742	-	64	125x110x81,5														
RECTO STEP 1 COVER 120x33 cm - OUT	12,9" x 47,2"	1	-	32	11,59	371	-	32	125x110x81,5														
RECTO STEP 2 COVERS 120x33 cm - OUT	12,9" x 47,2"	1	-	32	12,00	386	-	32	125x110x81,5														
RECTO STEP 120x33 cm - IN	12,9" x 47,2"	2	-	32	23,18	742	-	64	125x110x81,5														
RECTO STEP 1 COVER 120x33 cm - IN	12,9" x 47,2"	1	-	32	11,59	371	-	32	125x110x81,5														
RECTO STEP 2 COVERS 120x33 cm - IN	12,9" x 47,2"	1	-	32	12,00	386	-	32	125x110x81,5														
FULL STEP 120x33 cm - OUT	12,9" x 47,2"	2	-	40	32,40	1.296	-	80	125x110x81,5														
ZANQUIN RECTO 9x45 cm (D/I)	3,5" x 17,7"	8 set	-	99	19,20	1.901	-	792 set	-														
ZANQUIN COMPLETO 9x45 cm (D/I)	3,5" x 17,7"	8 set	-	99	19,21	1.902	-	792 set	-														
SKIRTING BOARD 9x60 cm	3,5" x 17,7"	10	-	144	11,73	1.689	-	1.440	110x95x110														
RISER 14,5x120 cm	5,3" x 47,2"	6	-	75	22,20	1.645	-	450	125x110x90														
WINDOW SILL 18x50 cm	7,1" x 19,6"	6	-	72	14,04	1.011	-	432	110x95x115														
WINDOW SILL 18x50 CUT	-	-	-	-	-	-	-	-	-														
Ref: BPSA E000 18x50 / VIER E000 18x50	-	-	-	-	-	-	-	-	-														
SAMOA																							
SAMOA EDGE - Ref: BPSA 0000 50x120	19,6" x 47,2"	1	-	42	25,50	1.071	-	42	125x110x84														
SAMOA EDGE CORNER PACK	-	1 set	-	-	-	-	-	-	-														
Ref: BPSA E000 50x120 / BPSA E000 50x120	-	/radio	-	-	-	-	-	-	-														
SAMOA CURVED EDGE	-	-	-	-	-	-	-	-	-														
Ref: BPSA RE000 50x_ / BPSA R000 50x_	-	-	-	-	-	-	-	-	-														
CRETA																							
CRETA EDGE - Ref: BPCR 0000 33x50	12,9" x 19,6"	2	-	60	13,60	816	-	120	110x85x80														
CRETA EDGE CORNER PACK	-	1 set	-	-	-	-	-	-	-														
Ref: BPCR E000 33x50 / BPCR E000 33x50	-	/radio	-	-	-	-	-	-	-														
CRETA CURVED EDGE	-	-	-	-	-	-	-	-	-														
Ref: BPCR RE000 33x_ / BPCR R000 33x_	-	-	-	-	-	-	-	-	-														

MIKONOS	MIKONOS EDGE	17,7"x 27,5"	2	-	22	30,10	663	-	44	110x75x90
	Ref. BPMI 0000 45x70									
	MIKONOS EDGE CORNER PACK	-	1 set	-	-	-	-	-	-	-
	Ref. BPME E000 45x70 / BPMI E100 45x70		/radio	-	-	-	-	-	-	-
	MIKONOS CURVED EDGE	-	-	-	-	-	-	-	-	-
	Ref. BPMI RE00 45X_ / BPMI RI00 45X_									
MAUI	MAUI EDGE - Ref. BPMA 0000 33x50	12,9"x 19,5"	2	-	60	13,30	798	-	120	110x85x80
	MAUI EDGE CORNER PACK	-	1 set	-	-	-	-	-	-	-
	Ref. BPMA E000 33x50 / BPMA E100 33x50		/radio	-	-	-	-	-	-	-
	MAUI CURVED EDGE	-	-	-	-	-	-	-	-	-
	Ref. BPMA RE00 33x_ / BPMA RI00 33x_									
BORA	BORA EDGE - Ref. BPB0 0000 20x50	7,9"x 19,6"	2	-	104	9,20	957	-	208	110x95x90
	BORA EDGE CORNER PACK	-	1 set	-	-	-	-	-	-	-
	Ref. BPB0 E000 20x50 / BPB0 E100 20x50		/radio	-	-	-	-	-	-	-
	BORA CURVED EDGE	-	-	-	-	-	-	-	-	-
	Ref. BPB0 RE00 20x_ / BPB0 RI00 20x_									
ARUBA	ARUBA EDGE - Ref. BPAP 0000 25x50	9,8"x 19,6"	2	-	66	11,11	748,26	-	132	110x95x90
	ARUBA EDGE CORNER PACK	-	1 set	-	-	-	-	-	-	-
	Ref. BPAP E000 25x50 / BPAP E100 25x50		/radio	-	-	-	-	-	-	-
	ARUBA CURVED EDGE - Ref. BPAP RE00 25x_ / BPAP RI00 25x_									
CANARIAS	CANARIAS SUPPORT EDGE - Ref. BSCA 0000 18x50	7,1"x 19,6"	2	-	88	9,32	835,16	-	176	110x95x90
	CANARIAS SUPPORT EDGE CORNER PACK	-	1 set	-	-	-	-	-	-	-
	Ref. BSCA E000 18x50 / BSCA E100 18x50		/radio	-	-	-	-	-	-	-
	CANARIAS CURVED SUPPORT EDGE	-	-	-	-	-	-	-	-	-
	Ref. BSCA RE00 18x_ / BSCA RI00 18x_									
RJ25 FLEX	CERAMIC DRAIN GRATE RJ25 - Ref. RJ25 0000 25x50	9,8"x 19,6"	2	-	96	9,60	922	-	192	110x105x90
	CERAMIC DRAIN GRATE RJ25 CORNER PACK	-	1 set	-	-	-	-	-	-	-
	Ref. RJ25 E000 25x_		/radio	-	-	-	-	-	-	-
	CURVED CERAMIC DRAIN GRATE RJ25	-	-	-	-	-	-	-	-	-
	Ref. RJ25 RE00 25x_ / RJ25 RI00 25x_									
	CERAMIC DRAIN GRATE RJ25 FLEX - Ref. RJ25 FLEX 25x50	9,8"x 19,6"	2	-	96	9,60	922	-	192	110x105x90
	CERAMIC DRAIN GRATE RJ25 FLEX CORNER PACK	-	1 set	-	152	4,20	638	-	152	-
	Ref. RJ25 E000 FLEX 25x_									
RJ20 FLEX	CERAMIC DRAIN GRATE RJ20 - Ref. RJ20 0000 20x50	7,9"x 19,6"	2	-	128	7,80	998	-	256	110x95x90
	CERAMIC DRAIN GRATE RJ20 CORNER PACK	-	1 set	-	-	-	-	-	-	-
	Ref. RJ20 E000 20x_		/radio	-	-	-	-	-	-	-
	CURVED CERAMIC DRAIN GRATE RJ20	-	-	-	-	-	-	-	-	-
	Ref. RJ20 RE00 20x_ / RJ20 RI00 20x_									
	CERAMIC DRAIN GRATE RJ20 FLEX - Ref. RJ20 FLEX 20x50	7,9"x 19,6"	2	-	128	7,80	998	-	256	110x95x90
	CERAMIC DRAIN GRATE RJ20 FLEX CORNER PACK	-	1 set	-	152	3,90	593	-	152	-
	Ref. RJ20 E000 FLEX 20x_									
TRIM	TRIM - Ref. MDCA E000 4,5x50 / MDCA 1000 5,5x50	1,8x19,77/21"x19,77"	-	-	-	-	-	-	-	-
	CORNER TRIM - Ref. MDCA E000 4,5x4,5 / MDCA E100 5,5x5,5	1,8"x1,87/2,1"x2,1"	-	-	-	-	-	-	-	-
	ANGLE TRIM - Ref. MDCA A000 6,5x6,5 / MDCA A100 6,5x6,5	2,5"x2,5"/2,5"x2,5"	-	-	-	-	-	-	-	-
	NOOK TRIM - Ref. MDCA CE00 4,5x16 / MDCA C100 5,5x16	1,8"x6,37/2,1"x6,3"	-	-	-	-	-	-	-	-
	DRAIN GRATE RUBBER - Ref. 7966	-	-	-	-	-	-	-	-	-
	EXTRA COST SPECIAL CURVE - Ref. 6624	-	-	-	-	-	-	-	-	-

(*) Tiles without rectify

(R) Rectified tiles

Weights may suffer variations

(◼) Cements: Snow

(◼) Cupira: Hueso + Marengo

(◼) Cupira: Multi + Marengo

(*) Cupira: Hueso

(*) Stomboli: Light

(*) Stomboli: Light + Cream

(*) Salem: Clar

POOL

POOL EDGES

DRAIN GRATES

SOLUTIONS



CERAMICA MAYOR S.A.
C.I.F. A-03108669

Parida Planet, s/n
03510 Callosa d'En Sarrià
(Alicante-España)
+34 945 881 175
info@ceramicamayor.com

www.ceramicamayor.com



CROSSCUT



CLOUD



PETRA



SALEM



DUNE



AMAZONIA



MIEL



CANELA



CLAR



LAO



BONE



SAND



ASH



CUPIRA



HUESO



MULTI



MARENGO



ETERNA



ALBA



ARGENT



CENDRA



CEMENTS



SNOW



WARM



SMOKE



STROMBOLI



LIGHT



CREAM



SILVER



WOODS



ARCTIC



NORDIC



OLIVO



SEA ROCK



MARFIL



CAMEL



CALACATTA



FRESH



TROPIC



TURQUETA



AGUAMARINA



BALI

ZATU



CERÁMICA MAYOR, S.A.

Dirección: Partida Planet, s/n. Callosa d'en Sarrià, Alicante,
España (03510)

Centro logístico: Poligono Industrial Supoi 8, Av. Boverot, 6, 12550
Almassora, Castellón

Teléfono: +34 965 881 175

Web: www.ceramicamayor.com

e-mail: info@ceramicamayor.com



Cerámica Mayor se reserva el derecho de hacer las modificaciones que considere oportunas. Debido a los procesos de impresión, los colores que aparecen en este catálogo deben considerarse aproximados, no exactos.

Toda la información de este catálogo está protegida por copyright. Está prohibida la reproducción total o parcial de los textos, imágenes y representaciones gráficas sin la autorización expresa de Cerámica Mayor.

Los ambientes que se muestran en este catálogo son sugerencias decorativas de carácter publicitario, debiéndose utilizar en la instalación real las instrucciones de colocación de Cerámica Mayor.

Mayor
CERÁMICA ■■■■

2023